

FAST RECOVERY DIODE

ARF221

| | |
|--------------------------|---------------|
| Repetitive voltage up to | 1400 V |
| Mean forward current | 416 A |
| Surge current | 4,5 kA |

FINAL SPECIFICATION

June 17 - Issue: 4

| Symbol | Characteristic | Conditions | T _j [°C] | Value | Unit |
|----------------------|-------------------------------------|--|------------------------|-----------------------|------------------|
| BLOCKING | | | | | |
| V _{RRM} | Repetitive peak reverse voltage | | 125 | 1400 | V |
| V _{RSM} | Non-repetitive peak reverse voltage | | 125 | 1500 | V |
| I _{RRM} | Repetitive peak reverse current | V=VRRM | 125 | 50 | mA |
| CONDUCTING | | | | | |
| I _{F(AV)} | Mean forward current | 180° sin, 50 Hz, Th=55°C, double side cooled | | 416 | A |
| I _{F(AV)} | Mean forward current | 180°square, 50 Hz, Th=55°C, double side cooled | | 412 | A |
| I _{FSM} | Surge forward current | Sine wave, 10 ms without reverse voltage | 125 | 4,5 | kA |
| I ² t | I ² t | | | 101 x 10 ³ | A ² s |
| V _{FM} | Forward voltage | Forward current = 600 A | 25 | 1,47 | V |
| V _{F(TO)} | Threshold voltage | | 125 | 1,05 | V |
| r _F | Forward slope resistance | | 125 | 0,700 | mohm |
| SWITCHING | | | | | |
| t _{rr} | Reverse recovery time | IF= 200A di/dt= 40 A/μs VR= 50V | 125 | 2 | μs |
| Q _{rr} | Reverse recovery charge | | | 50 | μC |
| I _{rr} | Peak reverse recovery current | | | 50 | A |
| s | Softness (s-factor), min | | | | |
| V _{FR} | Peak forward recovery | | 125 | | V |
| MOUNTING | | | | | |
| R _{th(j-h)} | Thermal impedance, DC | Junction to heatsink, double side cooled | | 95,0 | °C/kW |
| R _{th(c-h)} | Thermal impedance | Case to heatsink, double side cooled | | 20,0 | °C/kW |
| T _j | Operating junction temperature | | | -30 / 125 | °C |
| F | Mounting force | | | 4.5 / 5.0 | kN |
| | Mass | | | 55 | g |

ORDERING INFORMATION : ARF221 S 14

 standard specification VRRM/100

DISSIPATION CHARACTERISTICS

SQUARE WAVE (50Hz)

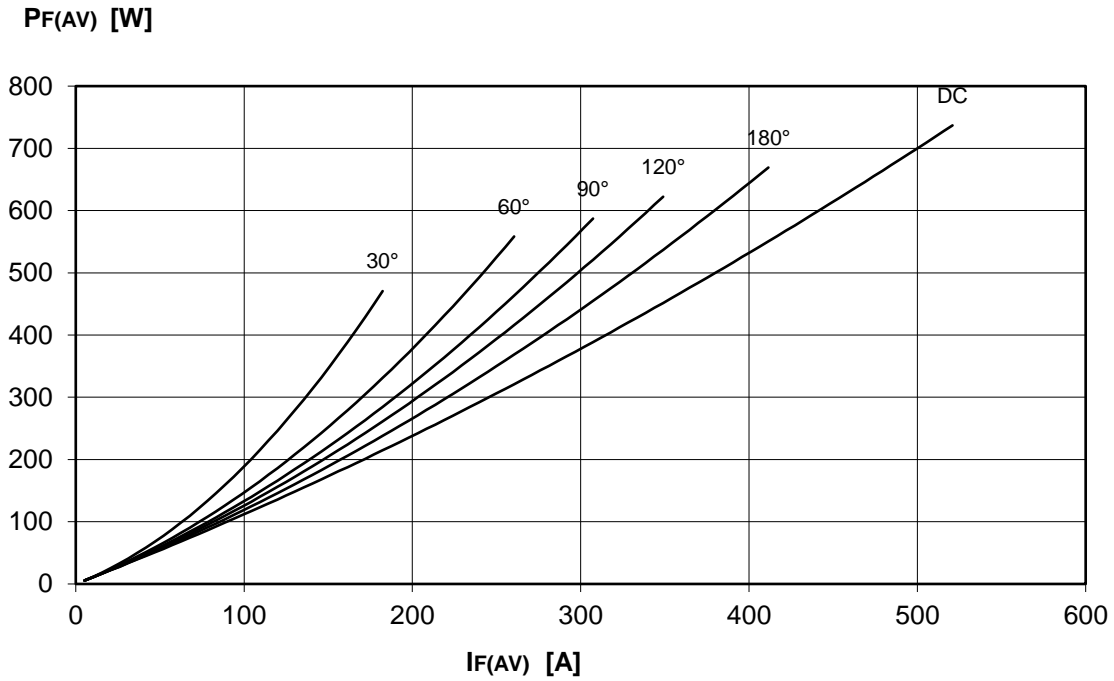

SINE WAVE (50Hz)

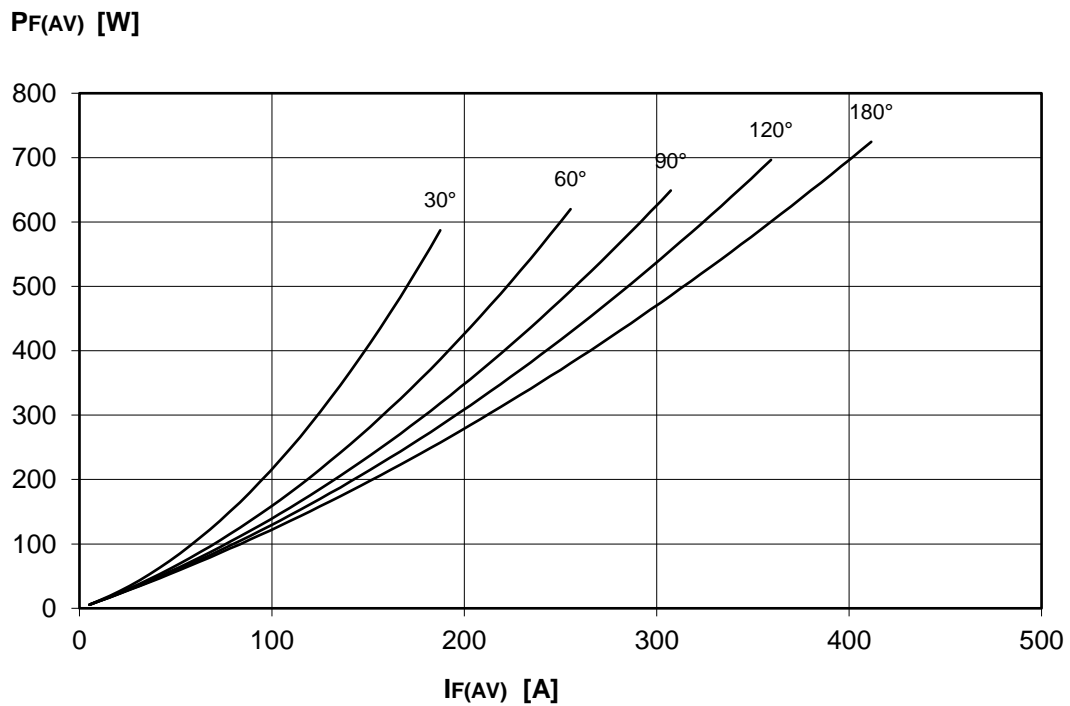

FORWARD RECOVERY VOLTAGE

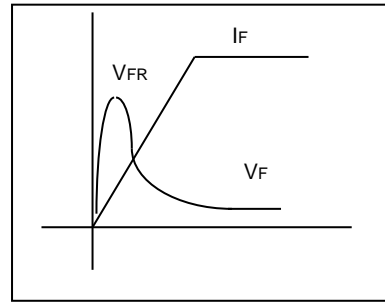
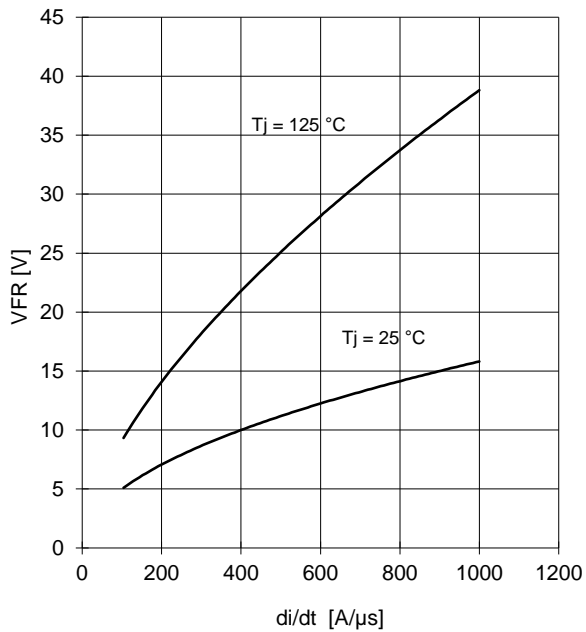

REVERSE RECOVERY CHARGE T_j = 125 °C

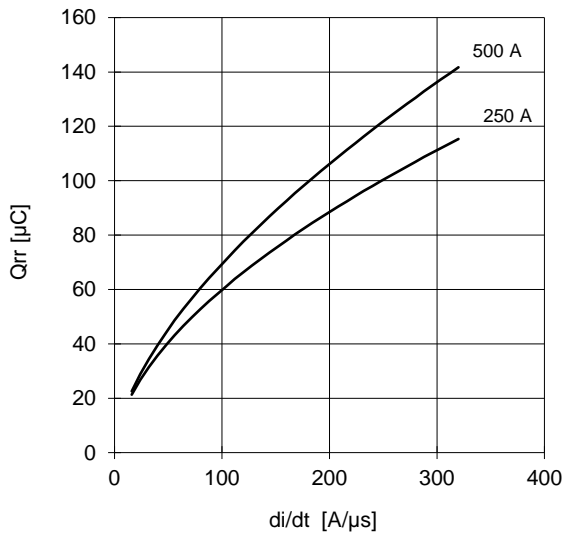

REVERSE RECOVERY CURRENT T_j = 125 °C

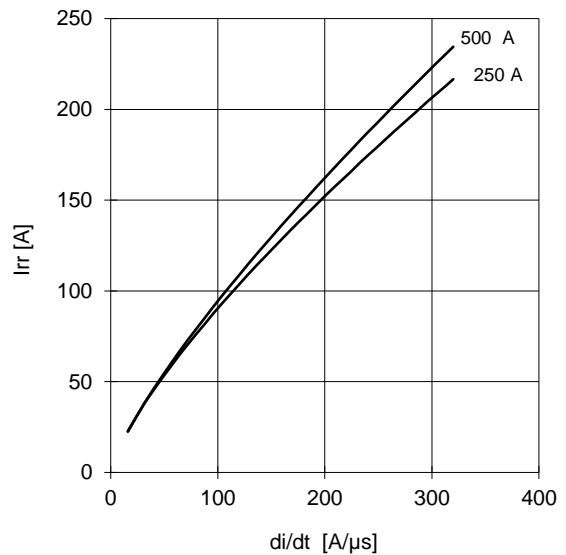

$$t_a = I_{rr} / (di/dt) \quad t_b = t_{rr} - t_a$$

$$\text{Softness (s factor)} \quad s = t_b / t_a$$

$$\text{Energy dissipation during recovery } E_r = V_r \cdot (Q_{rr} - I_{rr} \cdot t_a / 2)$$

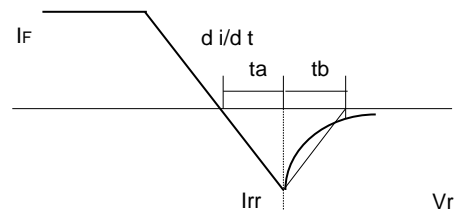

ARF221 FAST RECOVERY DIODE



FINAL SPECIFICATION June 17 - Issue: 4

FORWARD CHARACTERISTIC
T_j = 125 °C

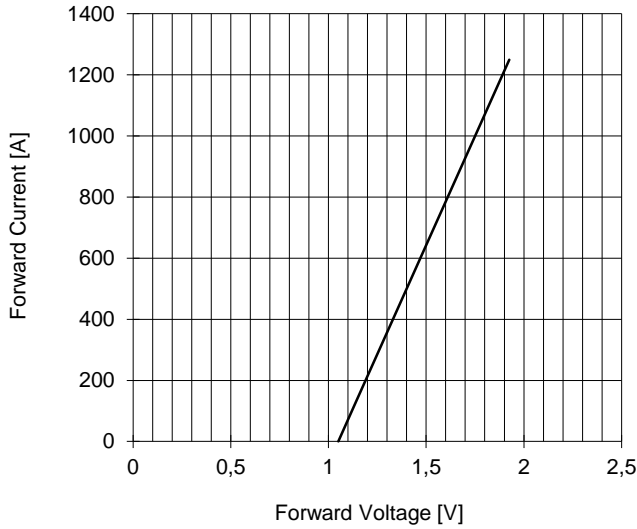

SURGE CHARACTERISTIC
T_j = 125 °C

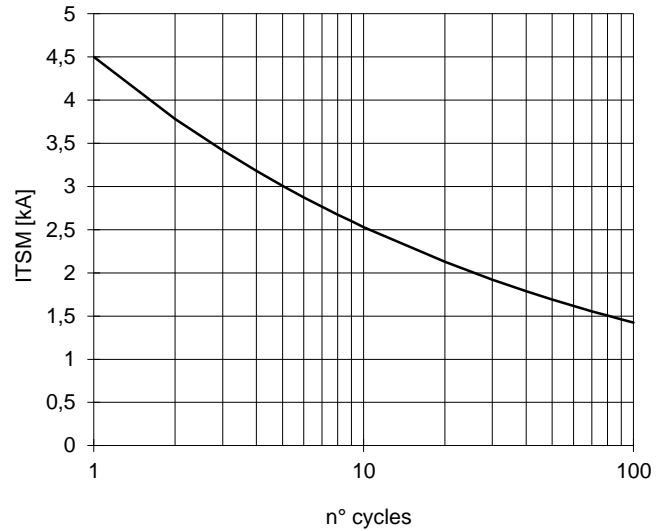

TRANSIENT THERMAL IMPEDANCE
DOUBLE SIDE COOLED

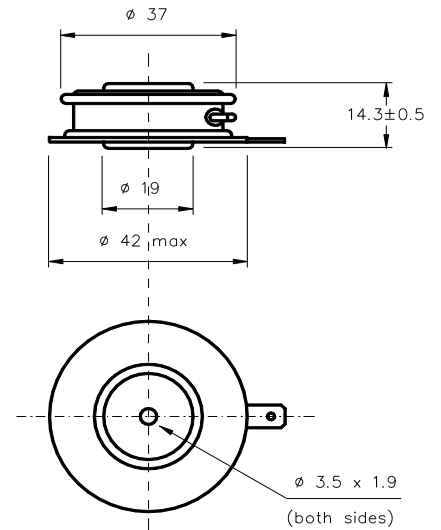
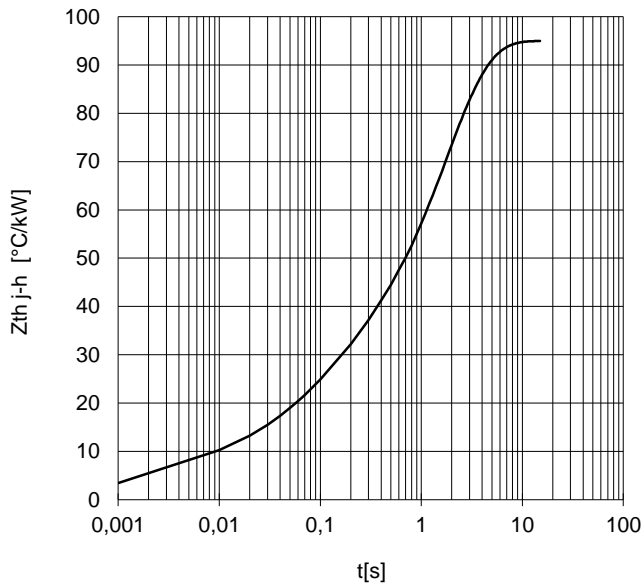

Dimensions
in mm



All the characteristics given in this data sheet are guaranteed only with uniform clamping force, cleaned and lubricated heatsink, surfaces with flatness < .03 mm and roughness < 2 μm. In the interest of product improvement POSEICO SpA reserves the right to change any data given in this data sheet at any time without previous notice. If not stated otherwise the maximum value of ratings (symbols over shaded background) and characteristics is reported.

Distributed by

