

FAST RECOVERY DIODE

ARF565

Repetitive voltage up to

3200 V

Mean forward current

1217 A

Surge current

14 kA
FINAL SPECIFICATION

June 17 - Issue: 4

Symbol	Characteristic	Conditions	T _j [°C]	Value	Unit
BLOCKING					
V _{RRM}	Repetitive peak reverse voltage		150	3200	V
V _{RSM}	Non-repetitive peak reverse voltage		150	3300	V
I _{RRM}	Repetitive peak reverse current	V=VRRM	150	75	mA
CONDUCTING					
I _{F(AV)}	Mean forward current	180° sin, 50 Hz, Th=55°C, double side cooled		1217	A
I _{F(AV)}	Mean forward current	180°square, 50 Hz, Th=55°C, double side cooled		1216	A
I _{FSM}	Surge forward current	Sine wave, 10 ms riapped reverse voltage up to 50% VRSM	150	14	kA
I ² t	I ² t			980 x 10 ³	A ² s
V _{FM}	Forward voltage	Forward current = 2000 A	25	2,50	V
V _{F(TO)}	Threshold voltage		150	1,50	V
r _F	Forward slope resistance		150	0,500	mohm
SWITCHING					
t _{rr}	Reverse recovery time	IF= 1000A	150	5	μs
Q _{rr}	Reverse recovery charge	di/dt= 100 A/μs		1000	μC
I _{rr}	Peak reverse recovery current	VR= 50V		420	A
s	Softness (s-factor), min			0,5	
V _{FR}	Peak forward recovery	di/dt = 100 A/μs	150	40	V
MOUNTING					
R _{th(j-h)}	Thermal impedance, DC	Junction to heatsink, double side cooled		26,0	°C/kW
R _{th(c-h)}	Thermal impedance	Case to heatsink, double side cooled		6,0	°C/kW
T _j	Operating junction temperature			-30 / 150	°C
F	Mounting force			18.0 / 20.0	kN
	Mass			500	g

ORDERING INFORMATION : ARF565 S 32

 standard specification VRRM/100

DISSIPATION CHARACTERISTICS

SQUARE WAVE (50Hz)

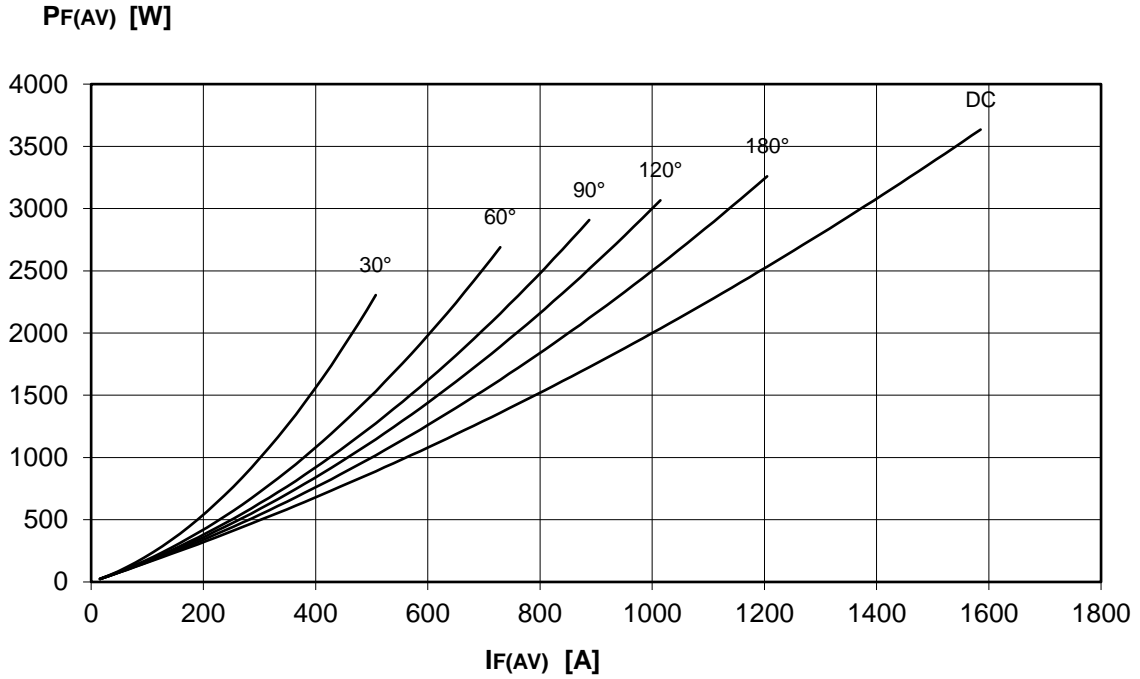

SINE WAVE (50Hz)

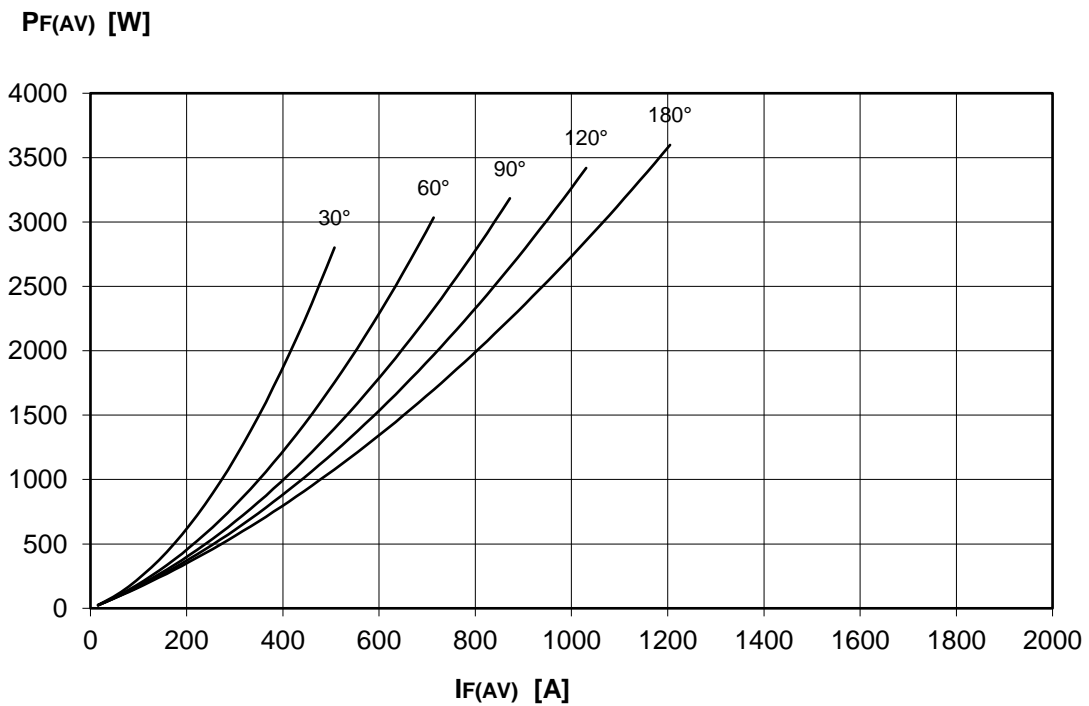

FORWARD RECOVERY VOLTAGE

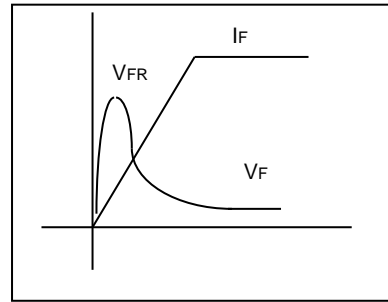
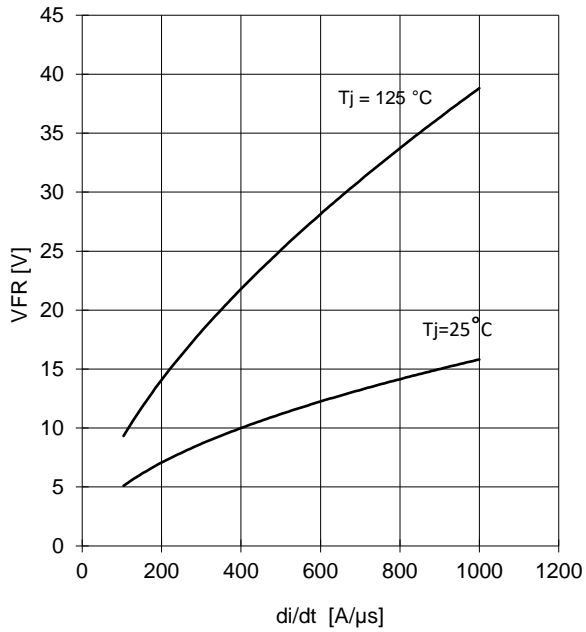

REVERSE RECOVERY CHARGE Tj = 150 °C

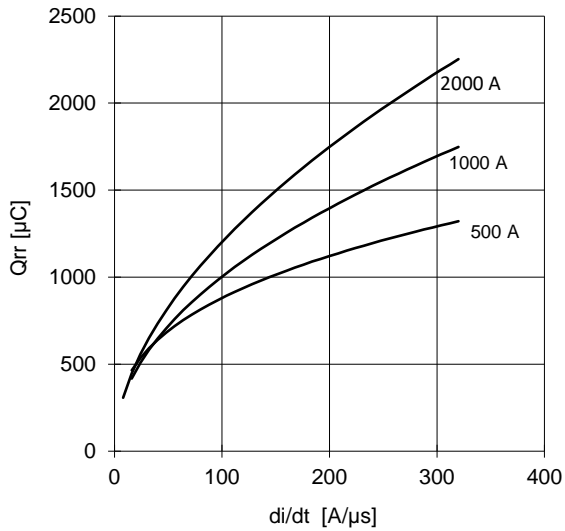

REVERSE RECOVERY CURRENT Tj = 150 °C

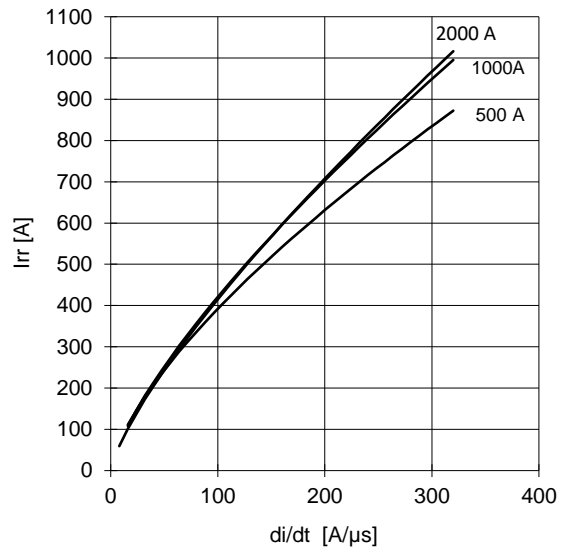

$$t_a = I_{rr} / (di/dt) \quad t_b = t_{rr} - t_a$$

$$\text{Softness (s factor)} \quad s = t_b / t_a$$

$$\text{Energy dissipation during recovery } E_r = V_r \cdot (Q_{rr} - I_{rr} \cdot t_a / 2)$$

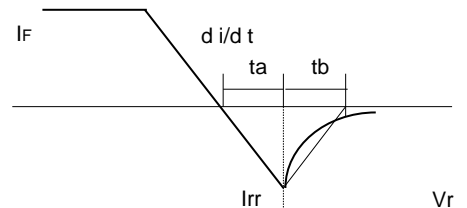

ARF565 FAST RECOVERY DIODE



FINAL SPECIFICATION June 17 - Issue: 4

FORWARD CHARACTERISTIC
T_j = 150 °C

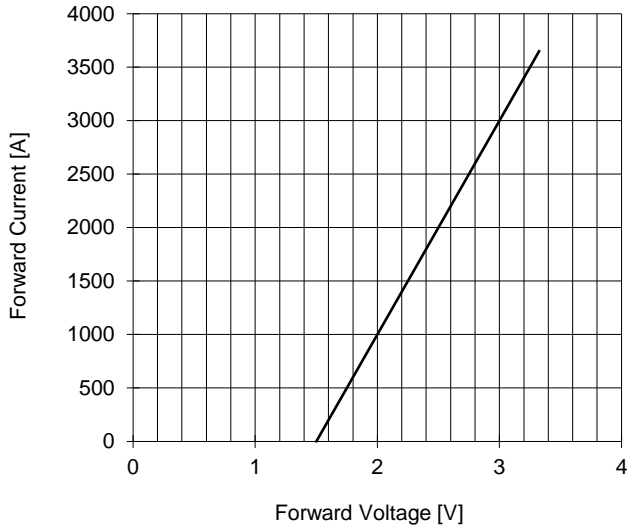

SURGE CHARACTERISTIC
T_j = 150 °C

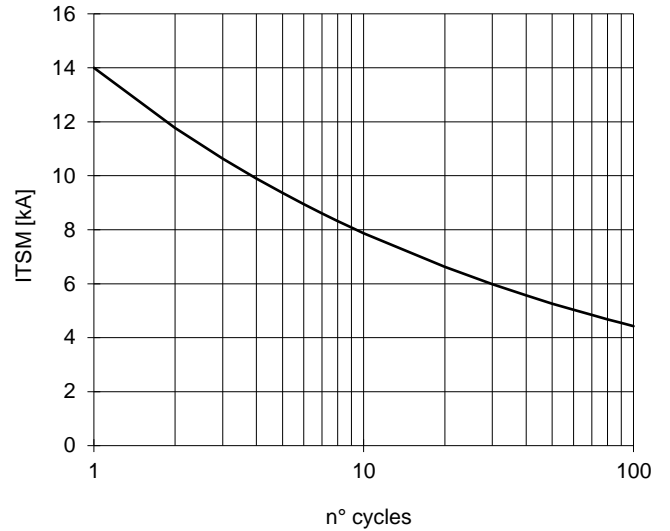

TRANSIENT THERMAL IMPEDANCE
DOUBLE SIDE COOLED

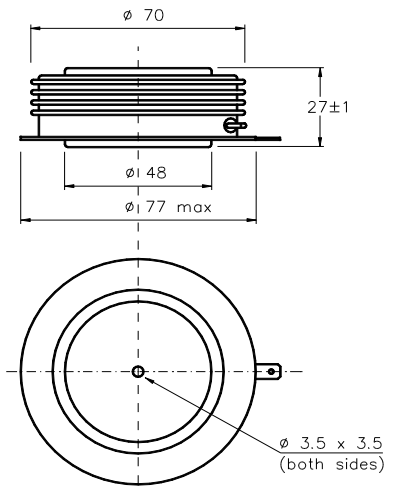
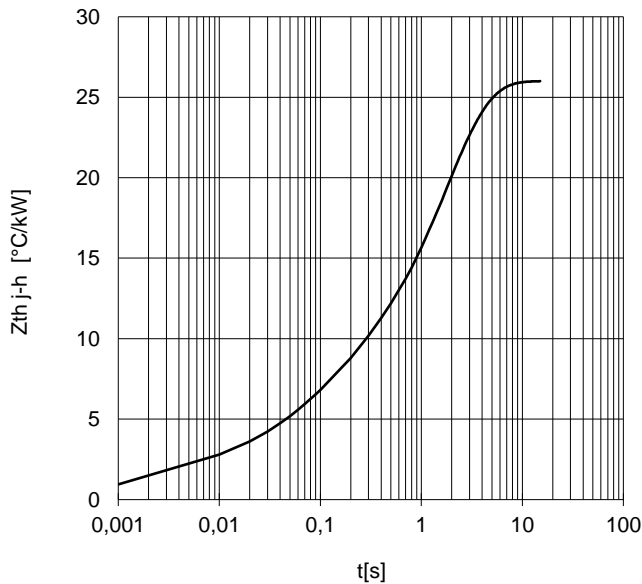

Dimensions
in mm



All the characteristics given in this data sheet are guaranteed only with uniform clamping force, cleaned and lubricated heatsink, surfaces with flatness < .03 mm and roughness < 2 μm. In the interest of product improvement POSEICO SpA reserves the right to change any data given in this data sheet at any time without previous notice. If not stated otherwise the maximum value of ratings (symbols over shaded background) and characteristics is reported.

Distributed by

