

**RECTIFIER DIODE**

# AR1109

Repetitive voltage up to	<b>4400 V</b>
Mean forward current	<b>1003 A</b>
Surge current	<b>10,3 kA</b>

**FINAL SPECIFICATION**

Mar. 17 - Issue: 6

Symbol	Characteristic	Conditions	T <sub>j</sub> [°C]	Value	Unit
<b>BLOCKING</b>					
V <sub>RRM</sub>	Repetitive peak reverse voltage		150	4400	V
V <sub>RSM</sub>	Non-repetitive peak reverse voltage		150	4500	V
I <sub>RRM</sub>	Repetitive peak reverse current	V=VRRM	150	50	mA
<b>CONDUCTING</b>					
I <sub>F(AV)</sub>	Mean forward current	180° sin, 50 Hz, Th=55°C, double side cooled		1003	A
I <sub>F(AV)</sub>	Mean forward current	180° sin, 50 Hz, Tc=85°C, double side cooled		904	A
I <sub>FSM</sub>	Surge forward current	Sine wave, 10 ms without reverse voltage	150	10,3	kA
I <sup>2</sup> t	I <sup>2</sup> t			530 x 10 <sup>3</sup>	A <sup>2</sup> s
V <sub>FM</sub>	Forward voltage	Forward current = 1800 A	25	1,80	V
V <sub>F(TO)</sub>	Threshold voltage		150	0,89	V
r <sub>F</sub>	Forward slope resistance		150	0,675	mohm
<b>SWITCHING</b>					
t <sub>rr</sub>	Reverse recovery time		150		μs
Q <sub>rr</sub>	Reverse recovery charge				μC
I <sub>rr</sub>	Peak reverse recovery current				A
<b>MOUNTING</b>					
R <sub>th(j-h)</sub>	Thermal impedance, DC	Junction to heatsink, double side cooled		37,0	°C/kW
R <sub>th(c-h)</sub>	Thermal impedance	Case to heatsink, double side cooled		7,0	°C/kW
T <sub>j</sub>	Operating junction temperature			-30 / 150	°C
F	Mounting force			11.8 / 13.2	kN
	Mass			300	g
<b>ORDERING INFORMATION : AR1109 S 44</b> standard specification <input type="checkbox"/> <input type="checkbox"/> VRRM/100					

**DISSIPATION CHARACTERISTICS**

SQUARE WAVE

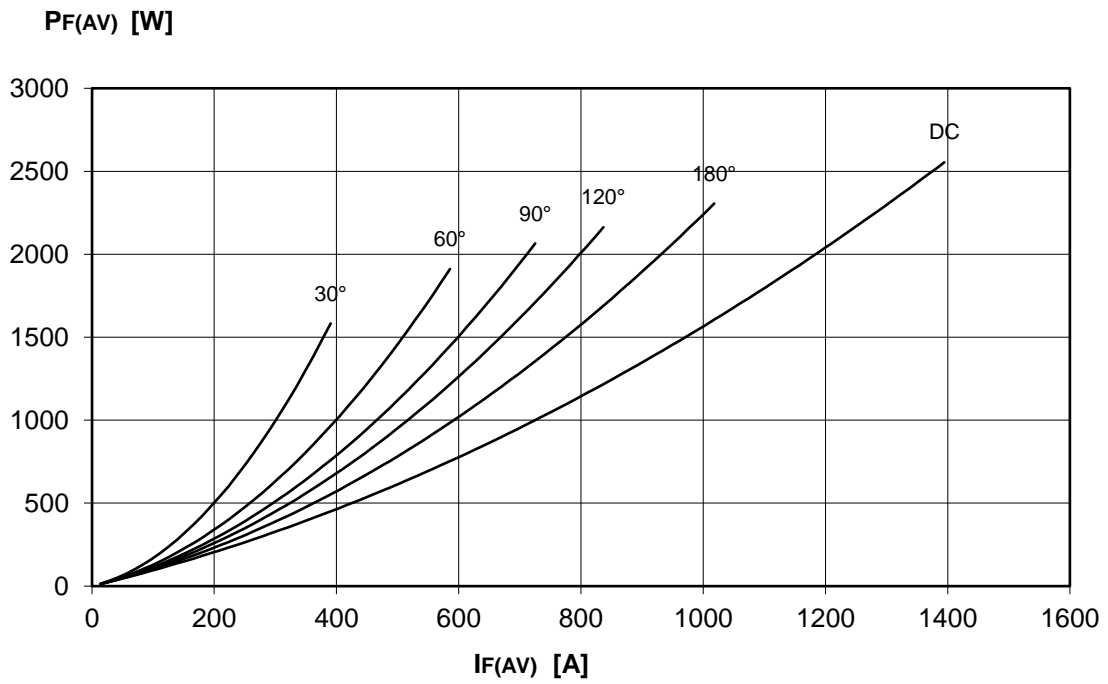
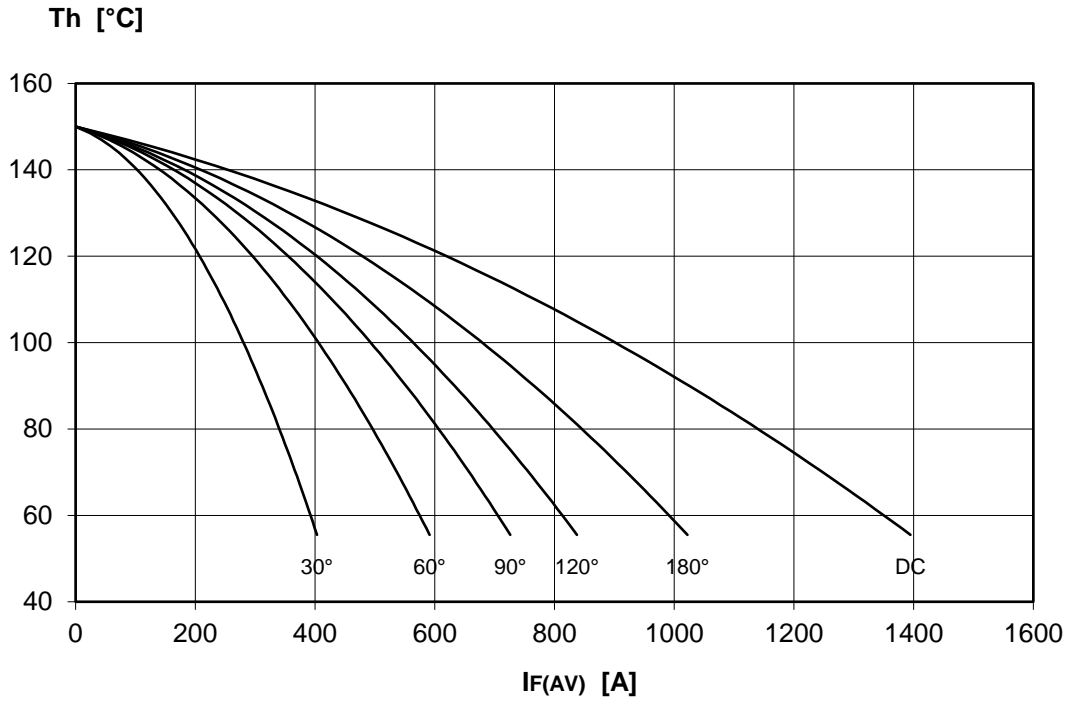

**DISSIPATION CHARACTERISTICS**

SINE WAVE

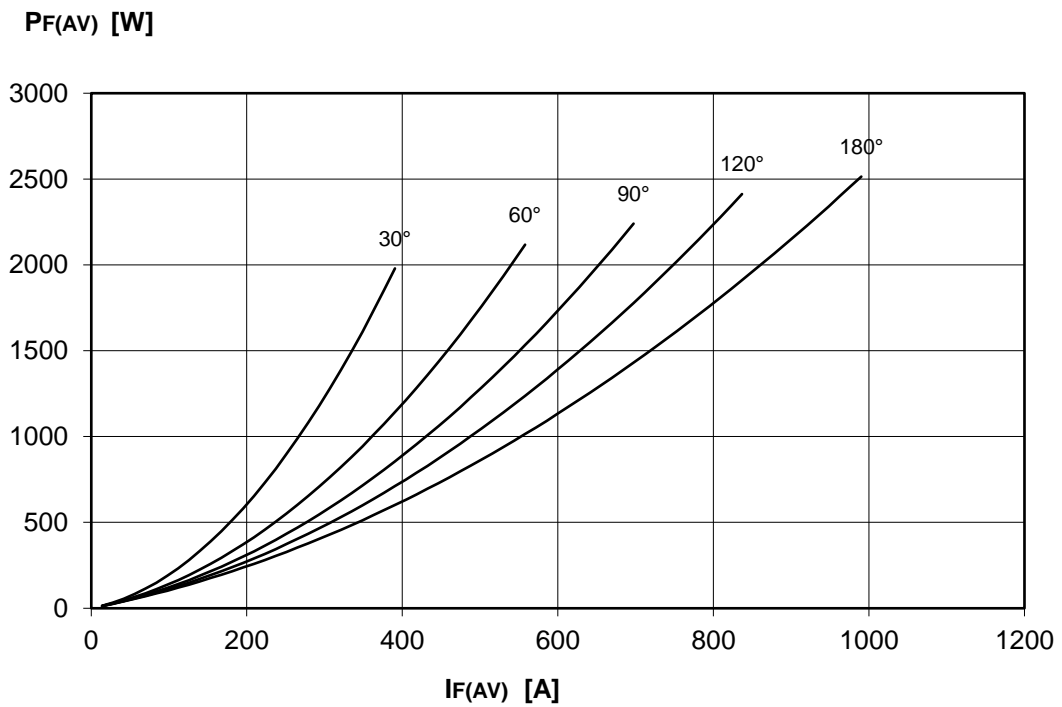
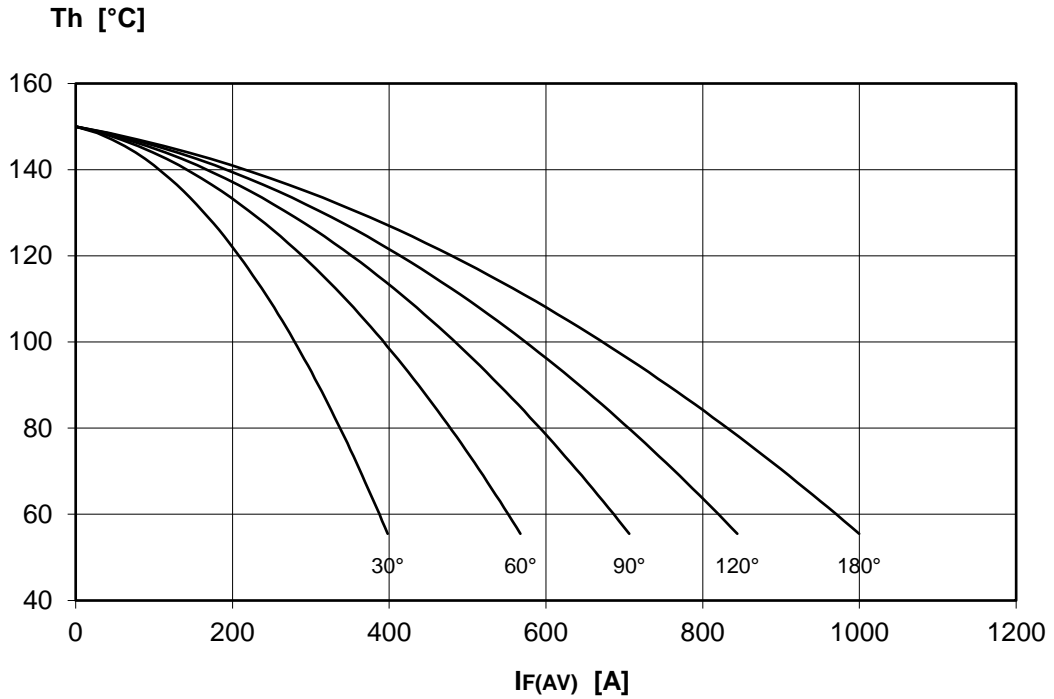

# AR1109 RECTIFIER DIODE



FINAL SPECIFICATION Mar. 17 - Issue: 6

FORWARD CHARACTERISTIC  
T<sub>j</sub> = 150 °C

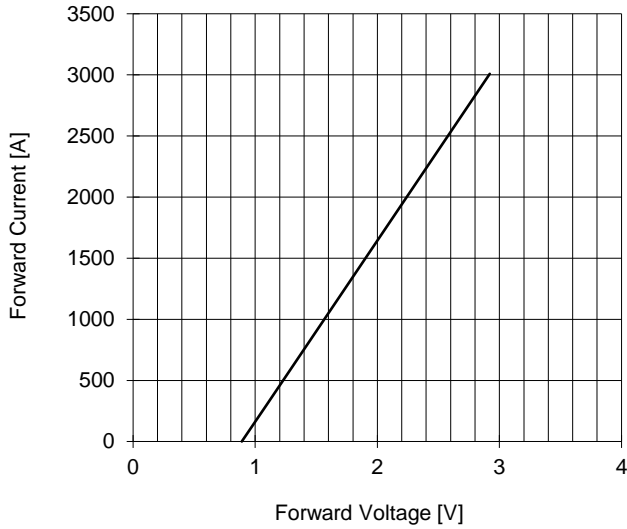

SURGE CHARACTERISTIC  
T<sub>j</sub> = 150 °C

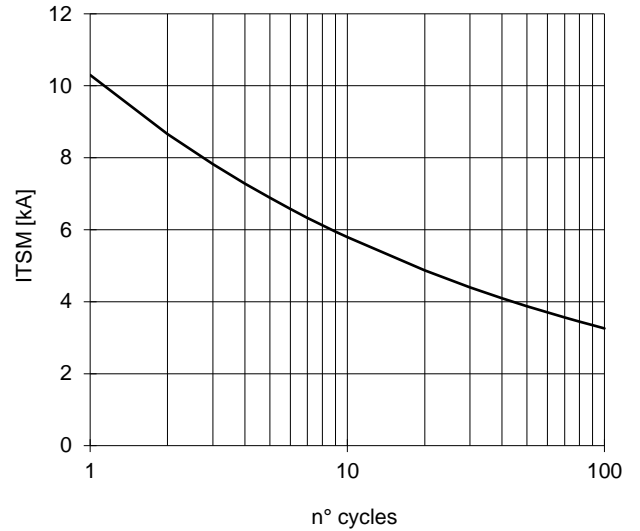

TRANSIENT THERMAL IMPEDANCE  
DOUBLE SIDE COOLED

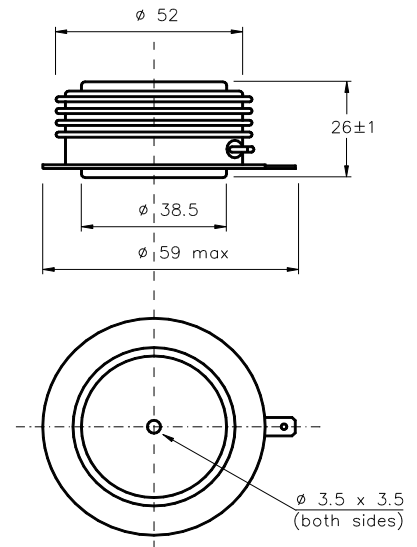
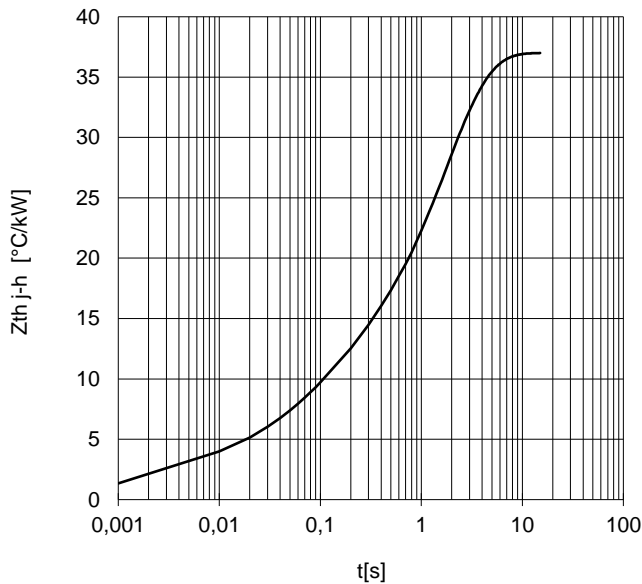

Dimensions  
in mm



Distributed by

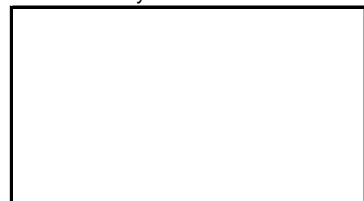

All the characteristics given in this data sheet are guaranteed only with uniform clamping force, cleaned and lubricated heatsink, surfaces with flatness < .03 mm and roughness < 2 μm.

In the interest of product improvement POSEICO SpA reserves the right to change any data given in this data sheet at any time without previous notice.

If not stated otherwise the maximum value of ratings (symbols over shaded background) and characteristics is reported.