

**RECTIFIER DIODE**

# AR340

|                          |                |
|--------------------------|----------------|
| Repetitive voltage up to | <b>2900 V</b>  |
| Mean forward current     | <b>1264 A</b>  |
| Surge current            | <b>10,1 kA</b> |

**FINAL SPECIFICATION**

Mar. 17 - Issue: 3

| Symbol  | Characteristic                      | Conditions                                   | T <sub>j</sub><br>[°C] | Value                 | Unit             |
|---|-------------------------------------|--|------------------------|-----------------------|------------------|
| <b>BLOCKING</b>   |                                     |  |                        |                       |                  |
| V <sub>RRM</sub>  | Repetitive peak reverse voltage     |  | 175                    | 2900                  | V                |
| V <sub>RSM</sub>  | Non-repetitive peak reverse voltage |  | 175                    | 3000                  | V                |
| I <sub>RRM</sub>  | Repetitive peak reverse current     | V=VRRM                                       | 175                    | 50                    | mA               |
| <b>CONDUCTING</b>   |                                     |  |                        |                       |                  |
| I <sub>F(AV)</sub>  | Mean forward current                | 180° sin, 50 Hz, Th=55°C, double side cooled |                        | 1264                  | A                |
| I <sub>F(AV)</sub>  | Mean forward current                | 180° sin, 50 Hz, Tc=85°C, double side cooled |                        | 1321                  | A                |
| I <sub>FSM</sub>  | Surge forward current               | Sine wave, 10 ms<br>without reverse voltage  | 175                    | 10,1                  | kA               |
| I <sup>2</sup> t  | I <sup>2</sup> t                    |  |                        | 510 x 10 <sup>3</sup> | A <sup>2</sup> s |
| V <sub>FM</sub>   | Forward voltage                     | Forward current = 1200 A                     | 25                     | 1,30                  | V                |
| V <sub>F(TO)</sub>  | Threshold voltage                   |  | 175                    | 0,87                  | V                |
| r <sub>F</sub>  | Forward slope resistance            |  | 175                    | 0,330                 | mohm             |
| <b>SWITCHING</b>  |                                     |  |                        |                       |                  |
| t <sub>rr</sub>   | Reverse recovery time               |  | 175                    |                       | μs               |
| Q <sub>rr</sub>   | Reverse recovery charge             |  |                        |                       | μC               |
| I <sub>rr</sub>   | Peak reverse recovery current       |  |                        |                       | A                |
| <b>MOUNTING</b>   |                                     |  |                        |                       |                  |
| R <sub>th(j-h)</sub>  | Thermal impedance, DC               | Junction to heatsink, double side cooled     |                        | 50,0                  | °C/kW            |
| R <sub>th(c-h)</sub>  | Thermal impedance                   | Case to heatsink, double side cooled         |                        | 15,0                  | °C/kW            |
| T <sub>j</sub>  | Operating junction temperature      |  |                        | -30 / 175             | °C               |
| F   | Mounting force                      |  |                        | 8.0 / 9.0             | kN               |
|   | Mass                                |  |                        | 280                   | g                |
| <b>ORDERING INFORMATION : AR340 S 29</b><br>standard specification  VRRM/100 |                                     |  |                        |                       |                  |

**DISSIPATION CHARACTERISTICS**

SQUARE WAVE

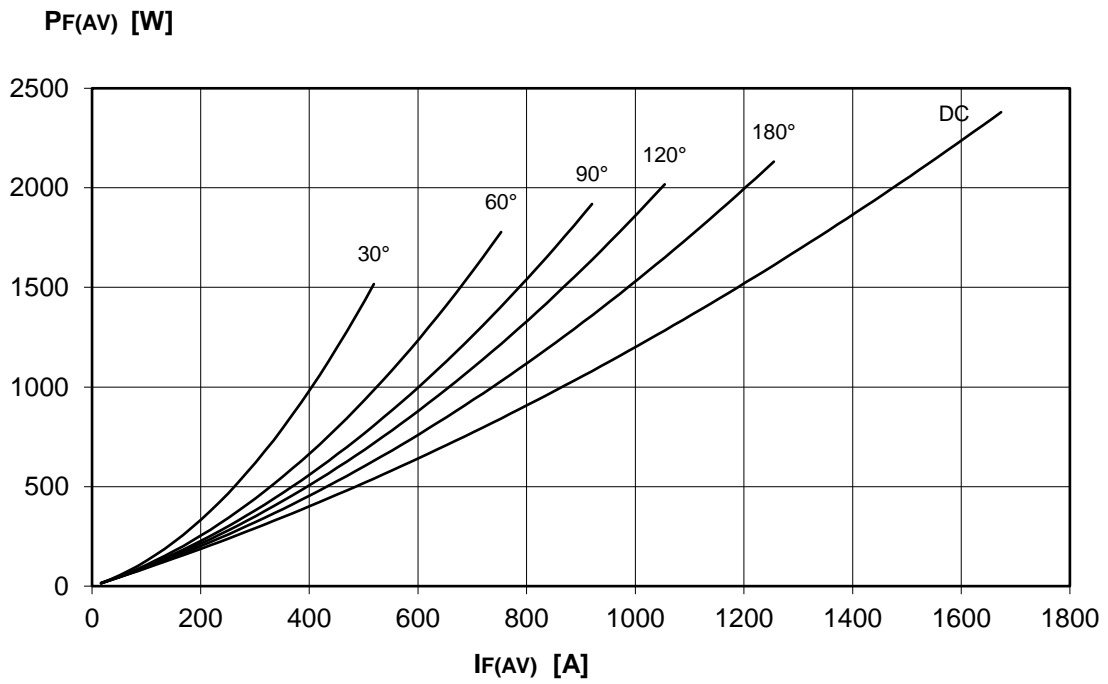
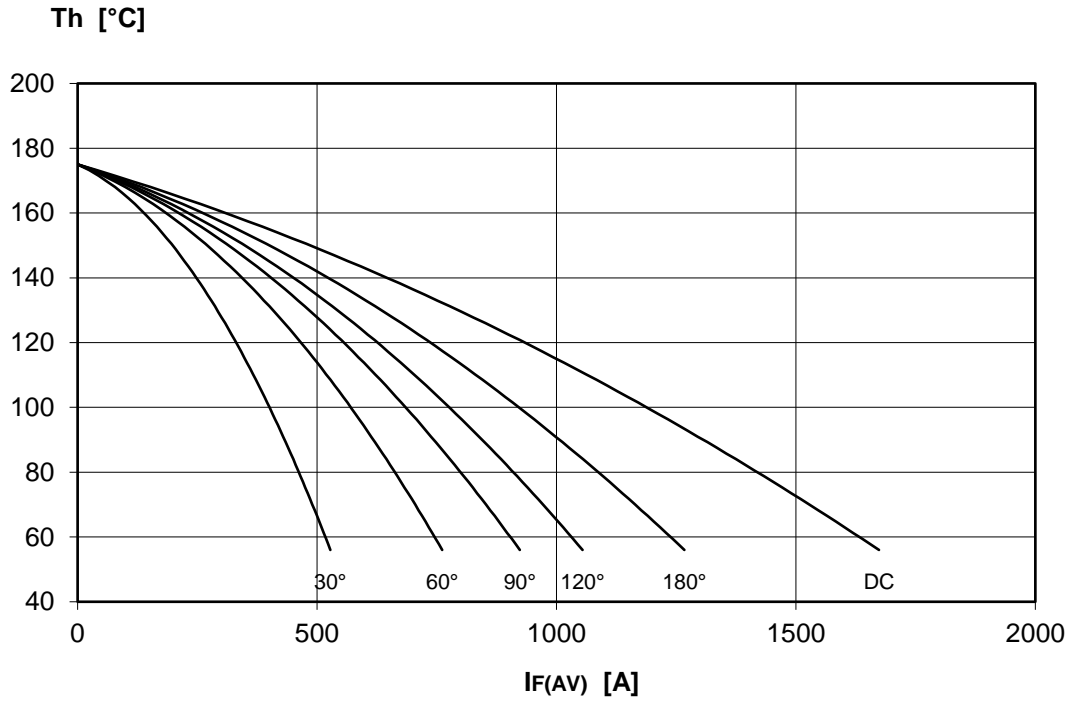

**DISSIPATION CHARACTERISTICS**

SINE WAVE

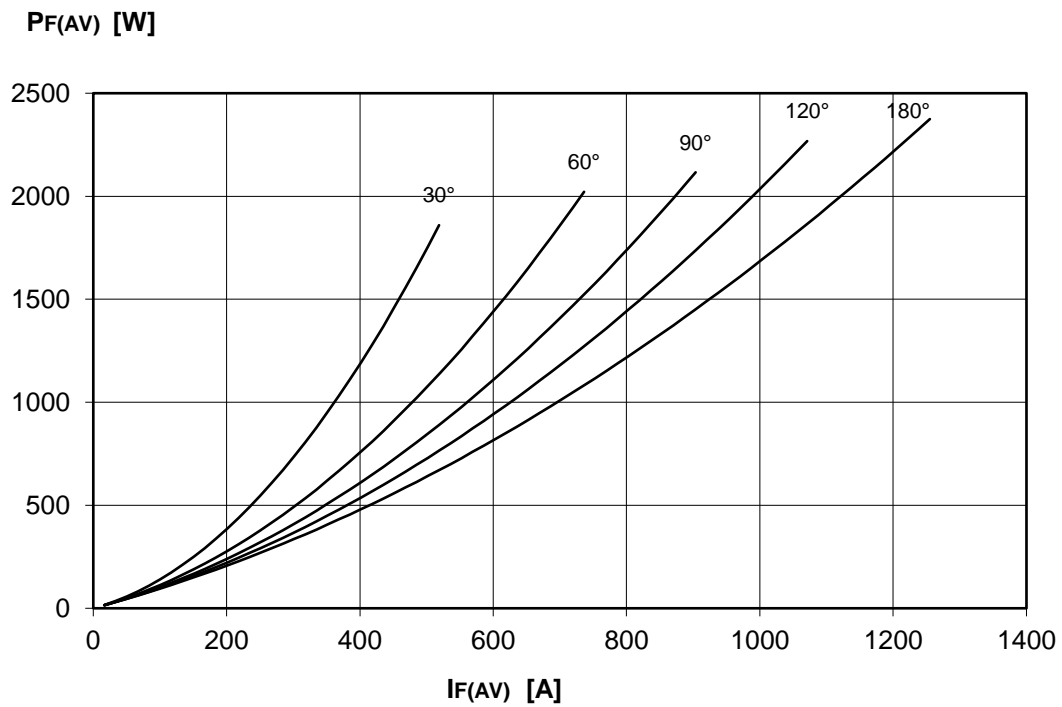
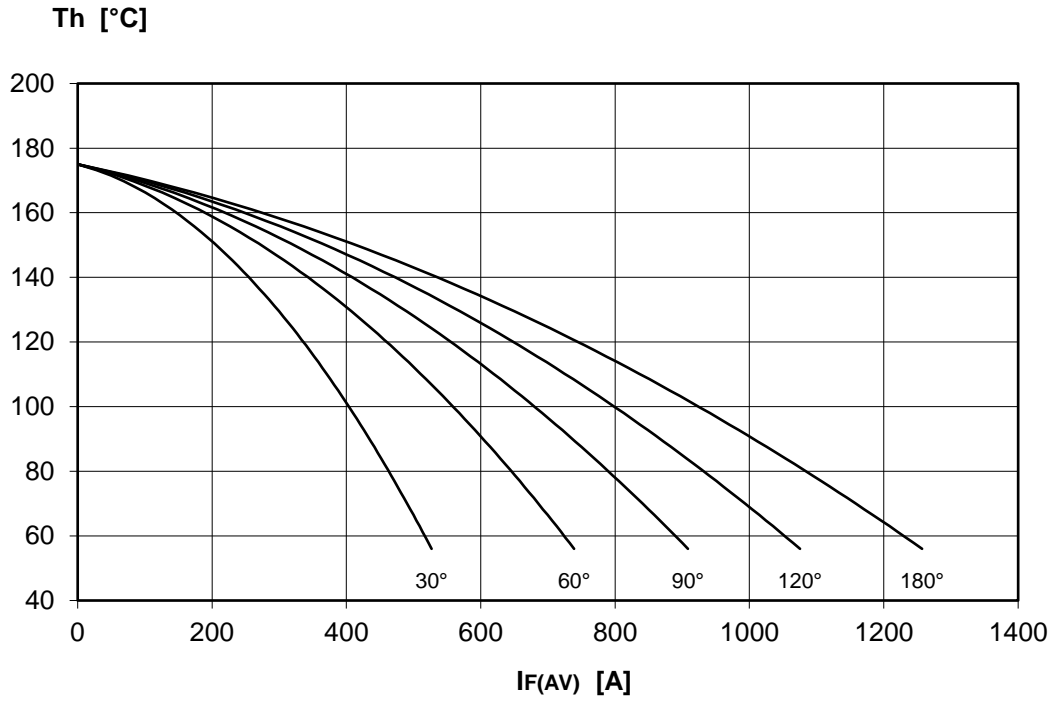

# AR340 RECTIFIER DIODE



FINAL SPECIFICATION Mar. 17 - Issue: 3

FORWARD CHARACTERISTIC  
T<sub>j</sub> = 175 °C

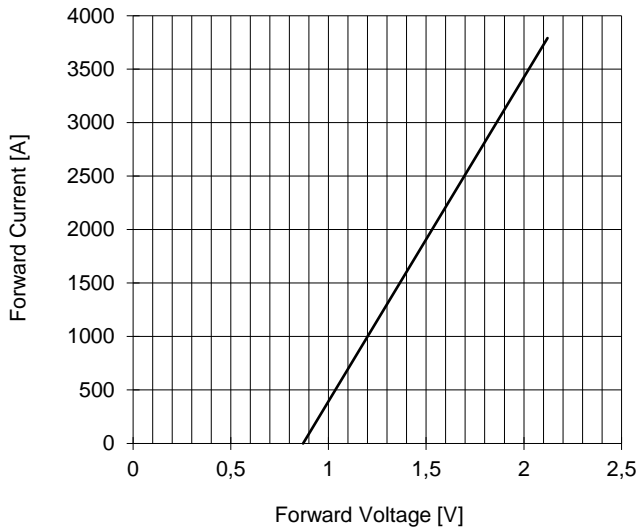

SURGE CHARACTERISTIC  
T<sub>j</sub> = 175 °C

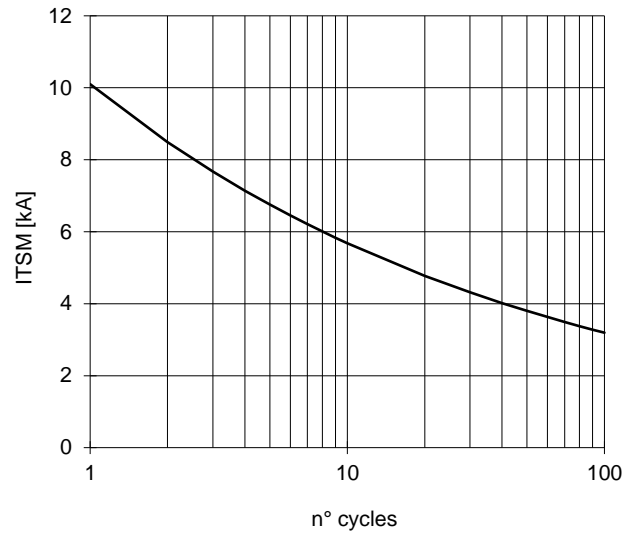

TRANSIENT THERMAL IMPEDANCE  
DOUBLE SIDE COOLED

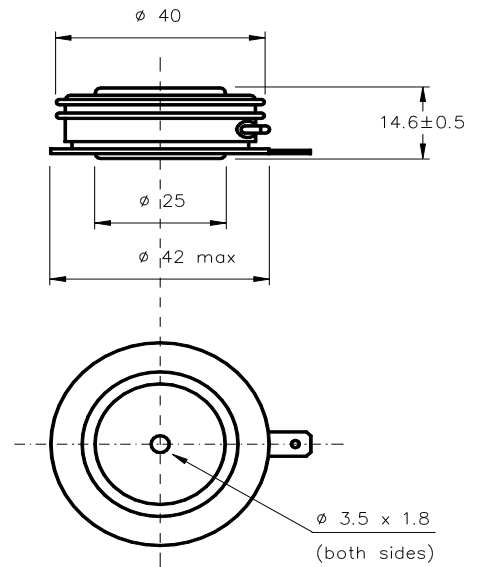
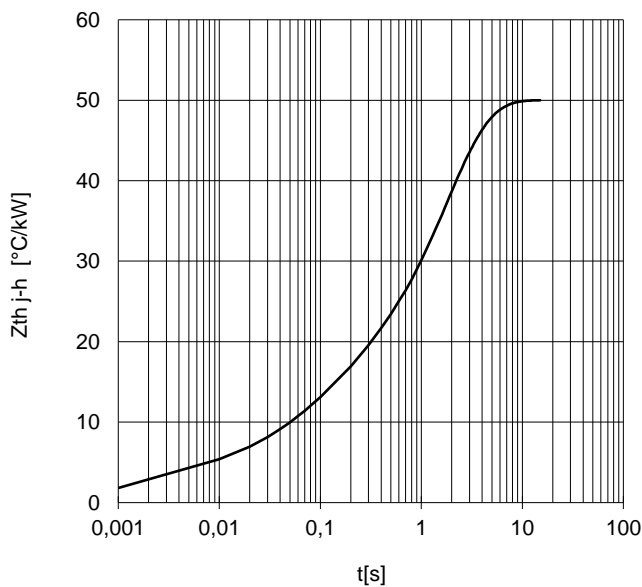

Dimensions  
in mm



Distributed by

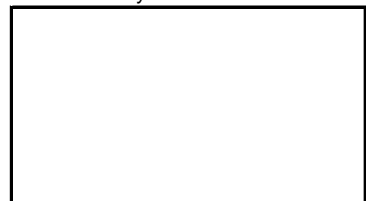

All the characteristics given in this data sheet are guaranteed only with uniform clamping force, cleaned and lubricated heatsink, surfaces with flatness < .03 mm and roughness < 2 μm.

In the interest of product improvement POSEICO SpA reserves the right to change any data given in this data sheet at any time without previous notice.

If not stated otherwise the maximum value of ratings (symbols over shaded background) and characteristics is reported.