

RECTIFIER DIODE

AR371

Repetitive voltage up to	3400 V
Mean forward current	886 A
Surge current	5,6 kA

FINAL SPECIFICATION

Mar. 17 - Issue: 3

Symbol	Characteristic	Conditions	T _j [°C]	Value	Unit
BLOCKING					
V _{RRM}	Repetitive peak reverse voltage		150	3400	V
V _{RSM}	Non-repetitive peak reverse voltage		150	3500	V
I _{RRM}	Repetitive peak reverse current	V=VRRM	150	50	mA
CONDUCTING					
I _{F(AV)}	Mean forward current	180° sin, 50 Hz, Th=55°C, double side cooled		886	A
I _{F(AV)}	Mean forward current	180° sin, 50 Hz, Tc=85°C, double side cooled		874	A
I _{FSM}	Surge forward current	Sine wave, 10 ms without reverse voltage	150	5,6	kA
I ² t	I ² t			157 x 10 ³	A ² s
V _{FM}	Forward voltage	Forward current =	150	0,70	V
V _{F(TO)}	Threshold voltage		150	0,70	V
r _F	Forward slope resistance		150	0,660	mohm
SWITCHING					
t _{rr}	Reverse recovery time		150		μs
Q _{rr}	Reverse recovery charge				μC
I _{rr}	Peak reverse recovery current				A
MOUNTING					
R _{th(j-h)}	Thermal impedance, DC	Junction to heatsink, double side cooled		50,0	°C/kW
R _{th(c-h)}	Thermal impedance	Case to heatsink, double side cooled		15,0	°C/kW
T _j	Operating junction temperature			-30 / 150	°C
F	Mounting force			8.0 / 9.0	kN
	Mass			85	g
ORDERING INFORMATION : AR371 S 34 standard specification  VRRM/100					

DISSIPATION CHARACTERISTICS

SQUARE WAVE

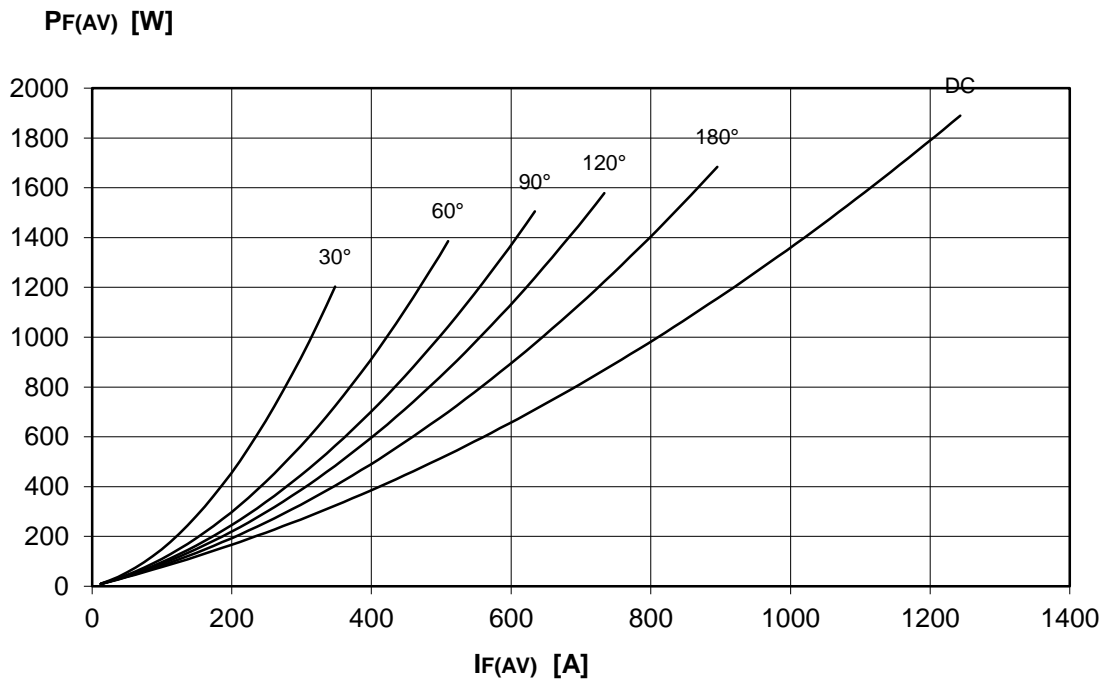
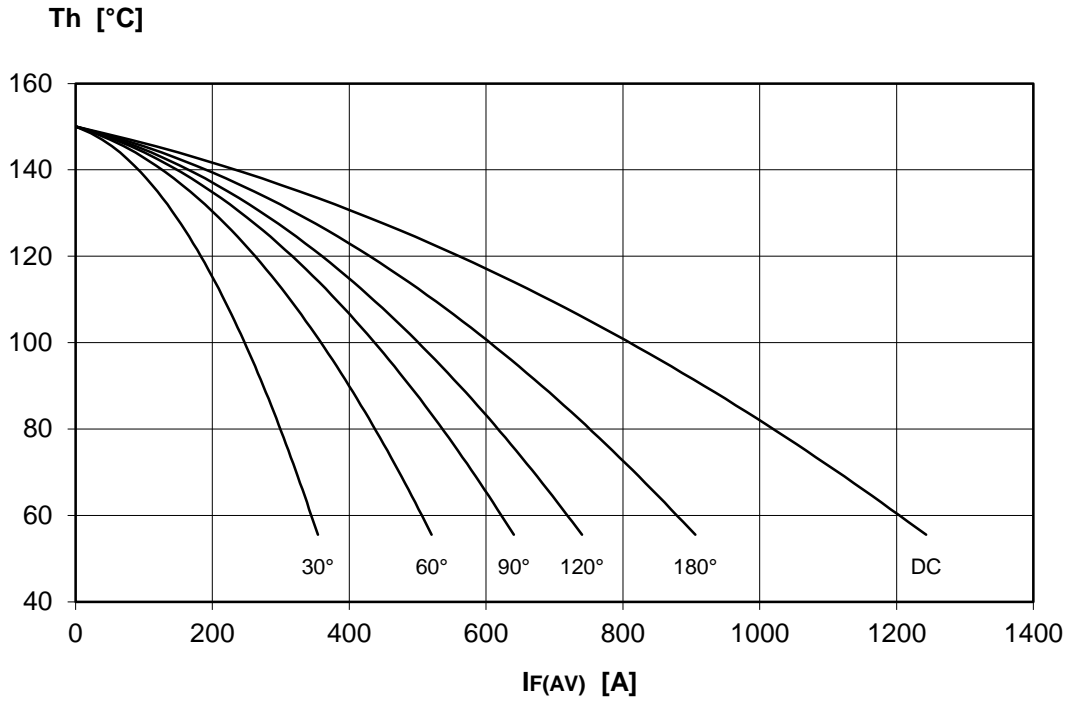

DISSIPATION CHARACTERISTICS

SINE WAVE

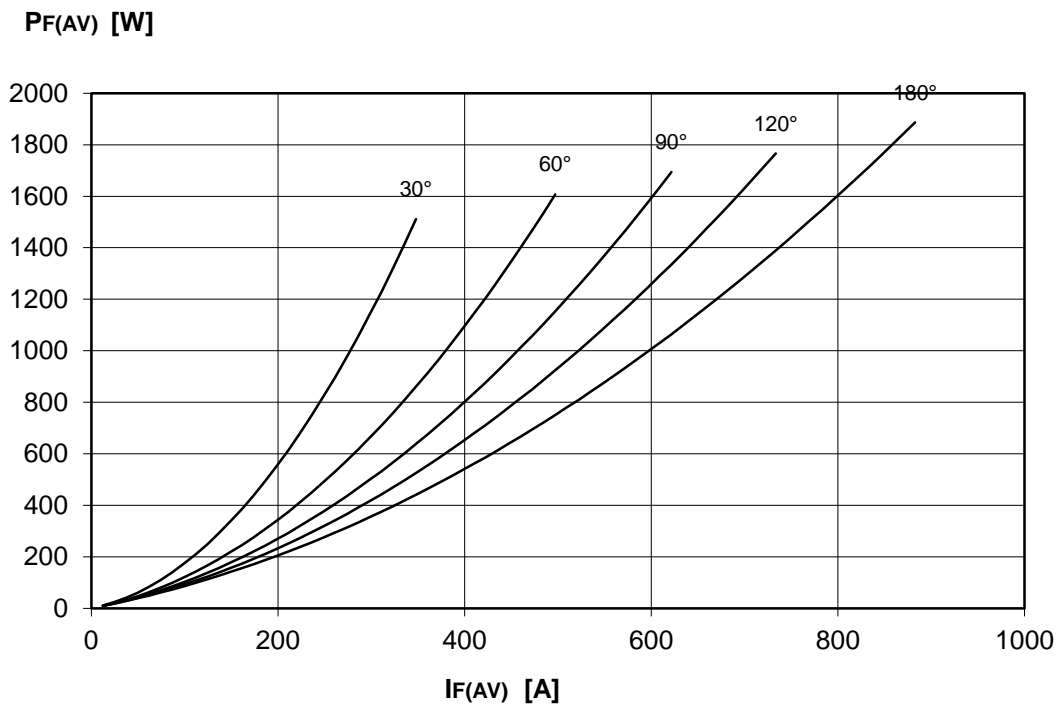
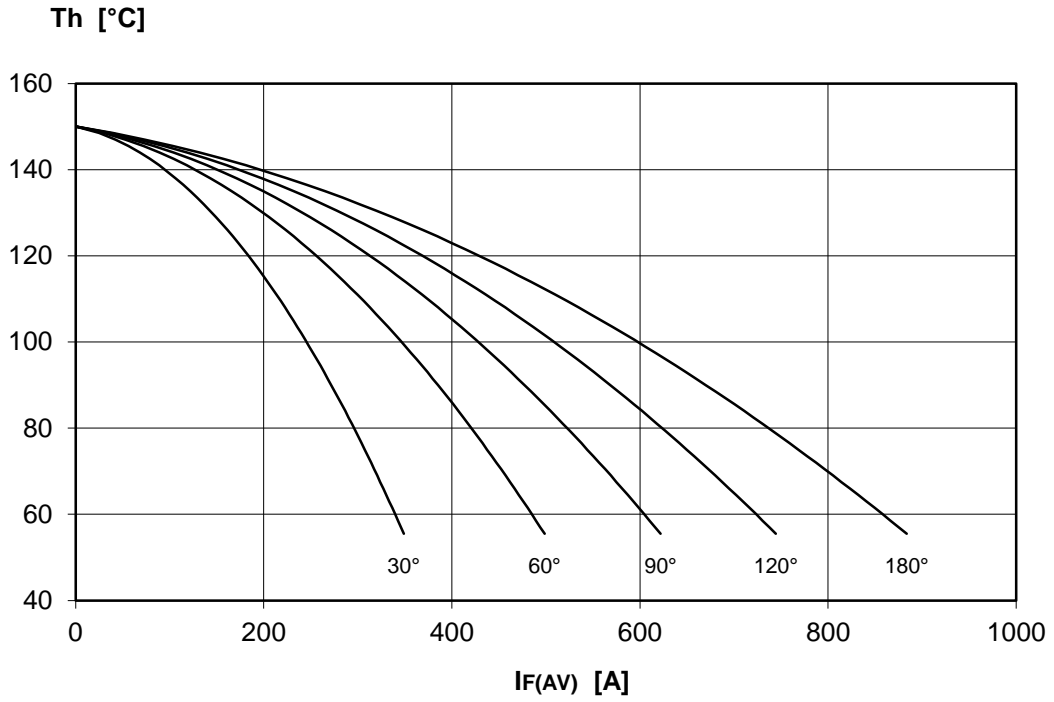

AR371 RECTIFIER DIODE



FINAL SPECIFICATION Mar. 17 - Issue: 3

FORWARD CHARACTERISTIC
T_j = 150 °C

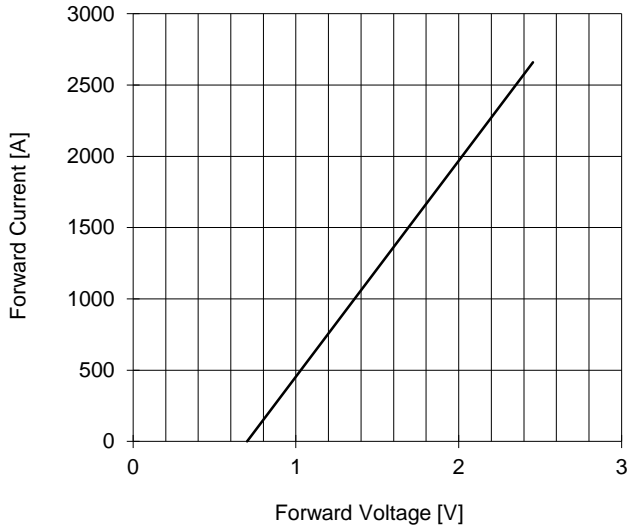

SURGE CHARACTERISTIC
T_j = 150 °C

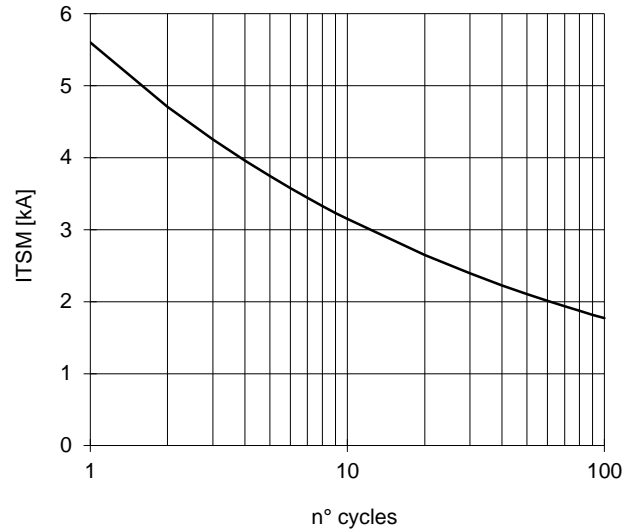

TRANSIENT THERMAL IMPEDANCE
DOUBLE SIDE COOLED

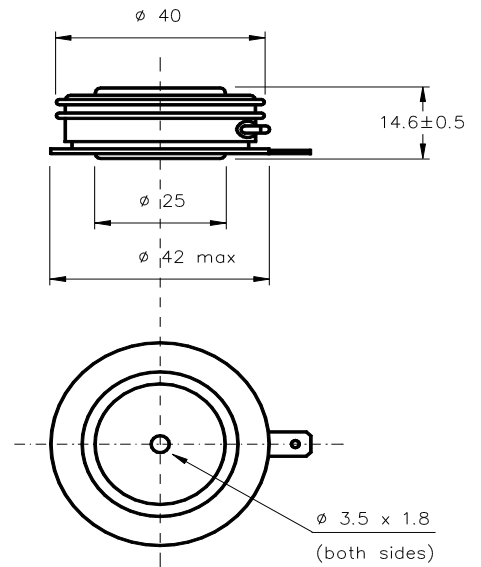
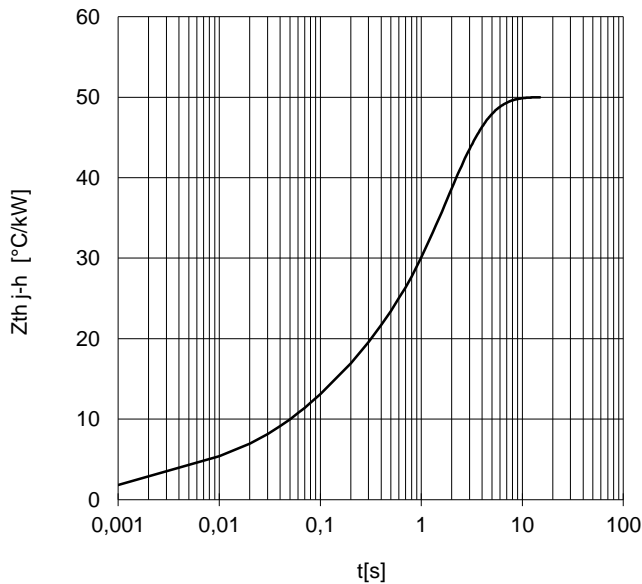

Dimensions
in mm

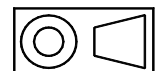

Distributed by

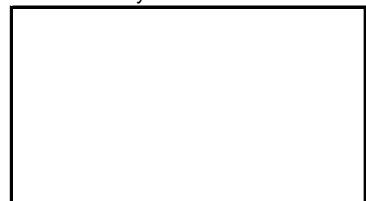

All the characteristics given in this data sheet are guaranteed only with uniform clamping force, cleaned and lubricated heatsink, surfaces with flatness < .03 mm and roughness < 2 μm.

In the interest of product improvement POSEICO SpA reserves the right to change any data given in this data sheet at any time without previous notice.

If not stated otherwise the maximum value of ratings (symbols over shaded background) and characteristics is reported.