

RECTIFIER DIODE

AR507LT

Repetitive voltage up to

600 V

Mean forward current

6798 A

Surge current

55 kA
FINAL SPECIFICATION

Jan. 20 - Issue: 3

Symbol	Characteristic	Conditions	T _j [°C]	Value	Unit
BLOCKING					
V _{RRM}	Repetitive peak reverse voltage		190	600	V
V _{RSM}	Non-repetitive peak reverse voltage		190	700	V
I _{RRM}	Repetitive peak reverse current	V=VRRM	190	75	mA
CONDUCTING					
I _{F(AV)}	Mean forward current	180° sin, 50 Hz, T _c =85°C, double side cooled		6798	A
I _{F(AV)}	Mean forward current	180° sin, 50 Hz, T _h =55°C, double side cooled		6358	A
I _{FSM}	Surge forward current	Sine wave, 10 ms without reverse voltage	190	55	kA
I ² t	I ² t			15125 x 10 ³	A ² s
V _{FM}	Forward voltage	Forward current = 4500 A	25	0,84	V
V _{F(TO)}	Threshold voltage		190	0,70	V
r _F	Forward slope resistance		190	0,035	mohm
SWITCHING					
t _{rr}	Reverse recovery time		190		μs
Q _{rr}	Reverse recovery charge				μC
I _{rr}	Peak reverse recovery current				A
MOUNTING					
R _{th(j-c)}	Thermal impedance, DC	Junction to case, double side cooled		12,0	°C/kW
R _{th(c-h)}	Thermal impedance	Case to heatsink, double side cooled		5,0	°C/kW
T _j	Operating junction temperature			-30 / 190	°C
F	Mounting force			20.0 / 22.0	kN
	Mass			150	g
ORDERING INFORMATION : AR507LT S 06 standard specification <input type="checkbox"/> <input type="checkbox"/> VRRM/100					

DISSIPATION CHARACTERISTICS

SQUARE WAVE

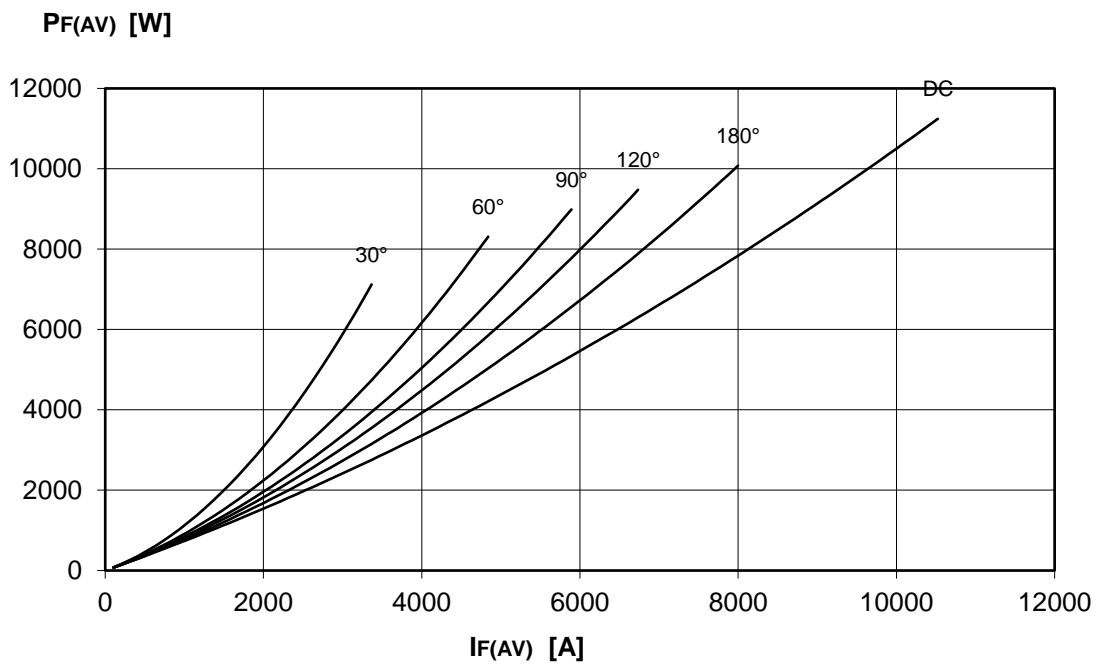
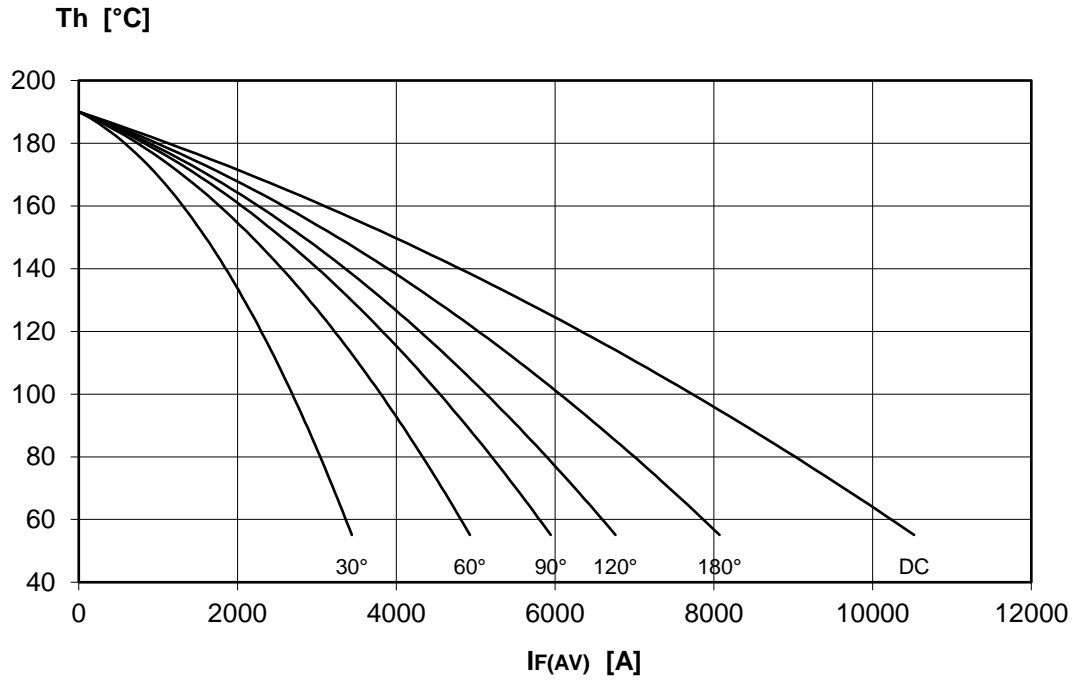

DISSIPATION CHARACTERISTICS

SINE WAVE

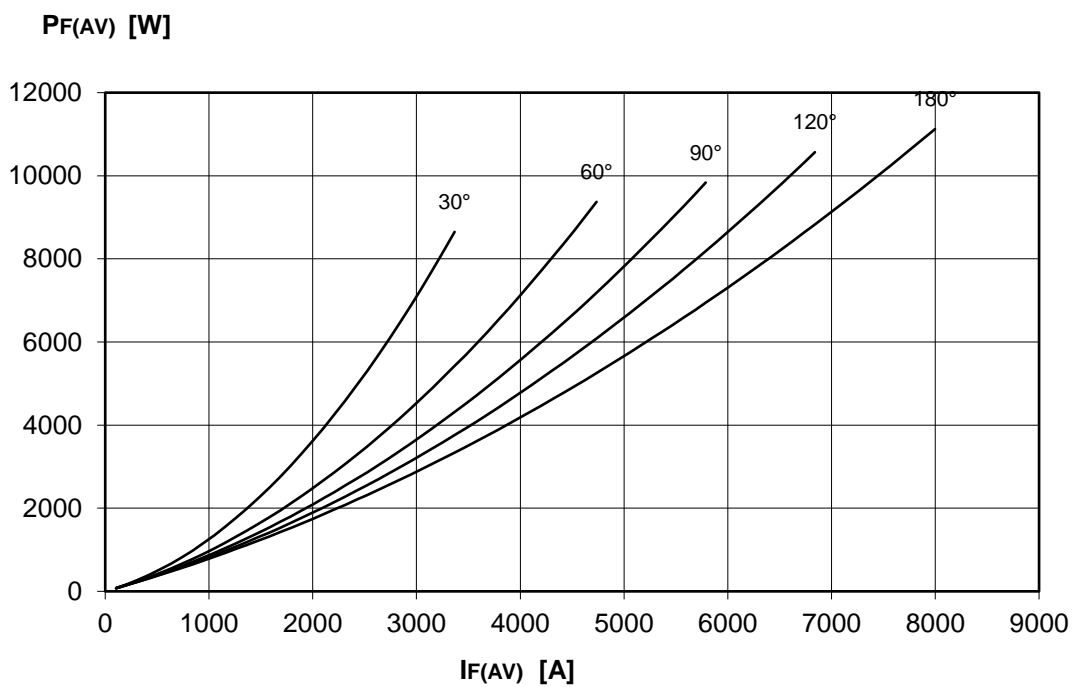
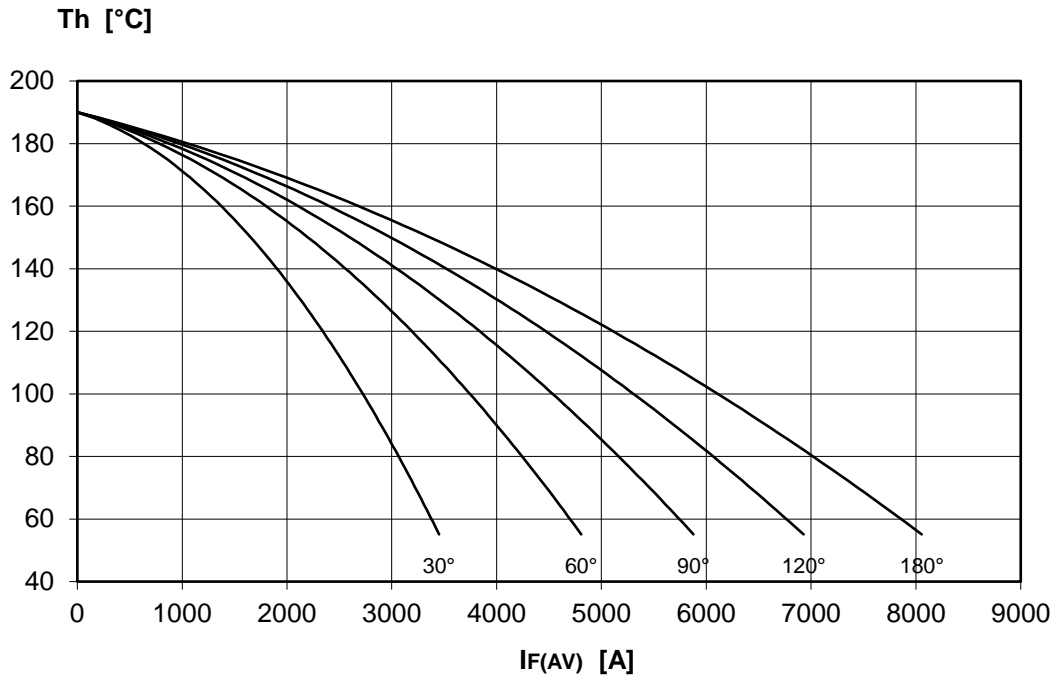

AR507LT RECTIFIER DIODE



FINAL SPECIFICATION Jan. 20 - Issue: 3

FORWARD CHARACTERISTIC
T_j = 190 °C

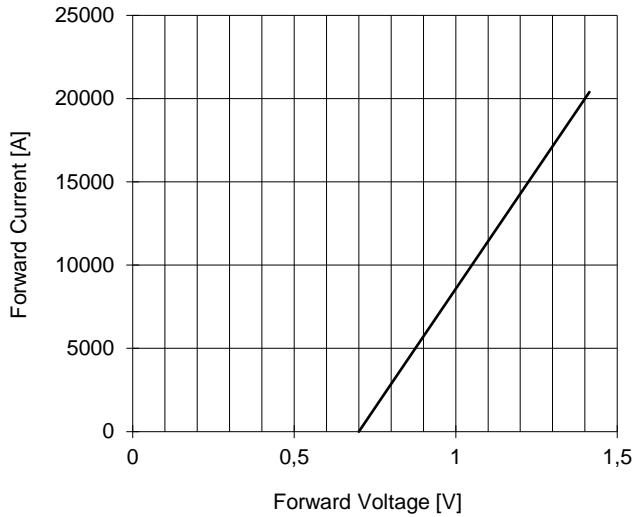

SURGE CHARACTERISTIC
T_j = 190 °C

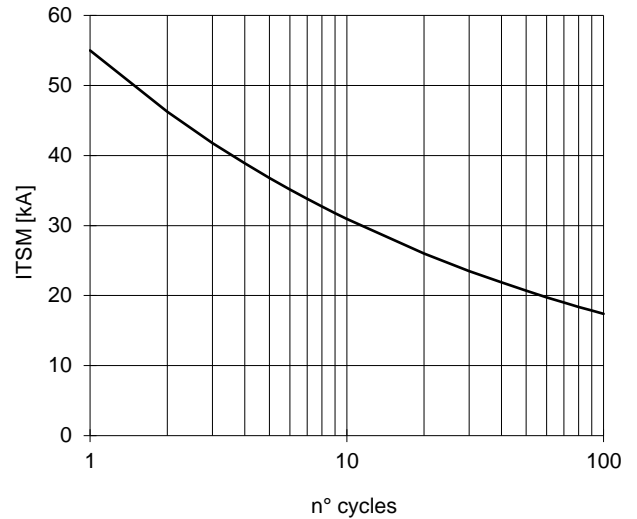

TRANSIENT THERMAL IMPEDANCE
DOUBLE SIDE COOLED

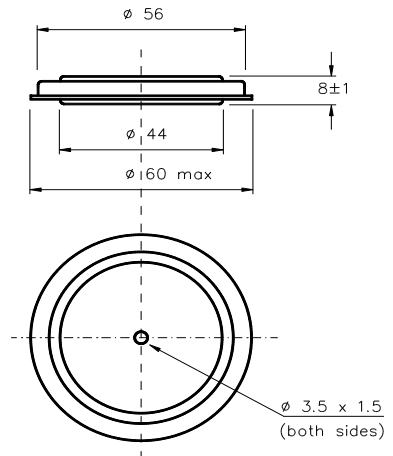
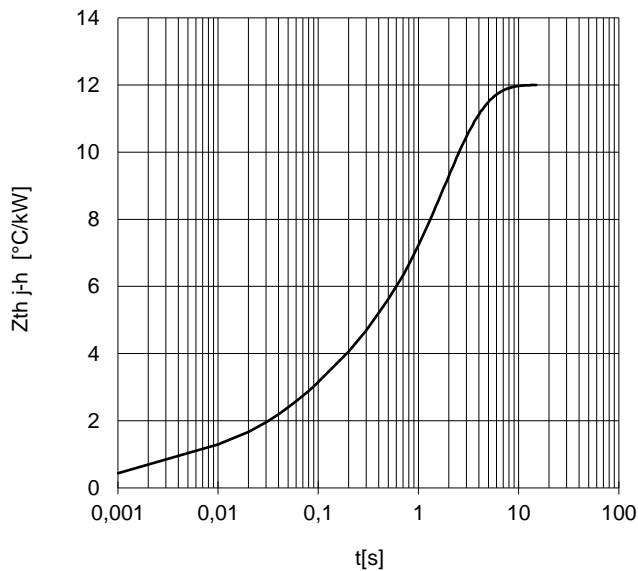

Dimensions
in mm



All the characteristics given in this data sheet are guaranteed only with uniform clamping force, cleaned and lubricated heatsink, surfaces with flatness < .03 mm and roughness < 2 μm .

In the interest of product improvement POSEICO SpA reserves the right to change any data given in this data sheet at any time without previous notice.

If not stated otherwise the maximum value of ratings (symbols over shaded background) and characteristics is reported.

Distributed by

