

RECTIFIER DIODE

AR679HT

Repetitive voltage up to	4500 V
Mean forward current	2659 A
Surge current	30 kA

FINAL SPECIFICATION

Feb. 18 - Issue: 0

Symbol	Characteristic	Conditions	T _j [°C]	Value	Unit
BLOCKING					
V _{RRM}	Repetitive peak reverse voltage		150	4500	V
V _{RSM}	Non-repetitive peak reverse voltage		150	4600	V
I _{RRM}	Repetitive peak reverse current	V=VRRM	150	150	mA
CONDUCTING					
I _{F(AV)}	Mean forward current	180° sin, 50 Hz, Th=55°C, double side cooled		2659	A
I _{F(AV)}	Mean forward current	180° sin, 50 Hz, Tc=75°C, double side cooled		2590	A
I _{FSM}	Surge forward current	Sine wave, 10 ms without reverse voltage	150	30	kA
I ² t	I ² t			4500 x 10 ³	A ² s
V _{FM}	Forward voltage	Forward current = 2000 A	150	1,19	V
V _{F(TO)}	Threshold voltage		150	0,79	V
r _F	Forward slope resistance		150	0,20	mohm
SWITCHING					
t _{rr}	Reverse recovery time		150		μs
Q _{rr}	Reverse recovery charge				μC
I _{rr}	Peak reverse recovery current				A
MOUNTING					
R _{th(j-h)}	Thermal impedance, DC	Junction to heatsink, double side cooled		17,0	°C/kW
R _{th(c-h)}	Thermal impedance	Case to heatsink, double side cooled		3,0	°C/kW
T _j	Operating junction temperature			-30 / 150	°C
F	Mounting force			40.0 / 50.0	kN
	Mass			850	g
ORDERING INFORMATION : AR679HT S 45					
standard specification  VRRM/100					

DISSIPATION CHARACTERISTICS

SQUARE WAVE

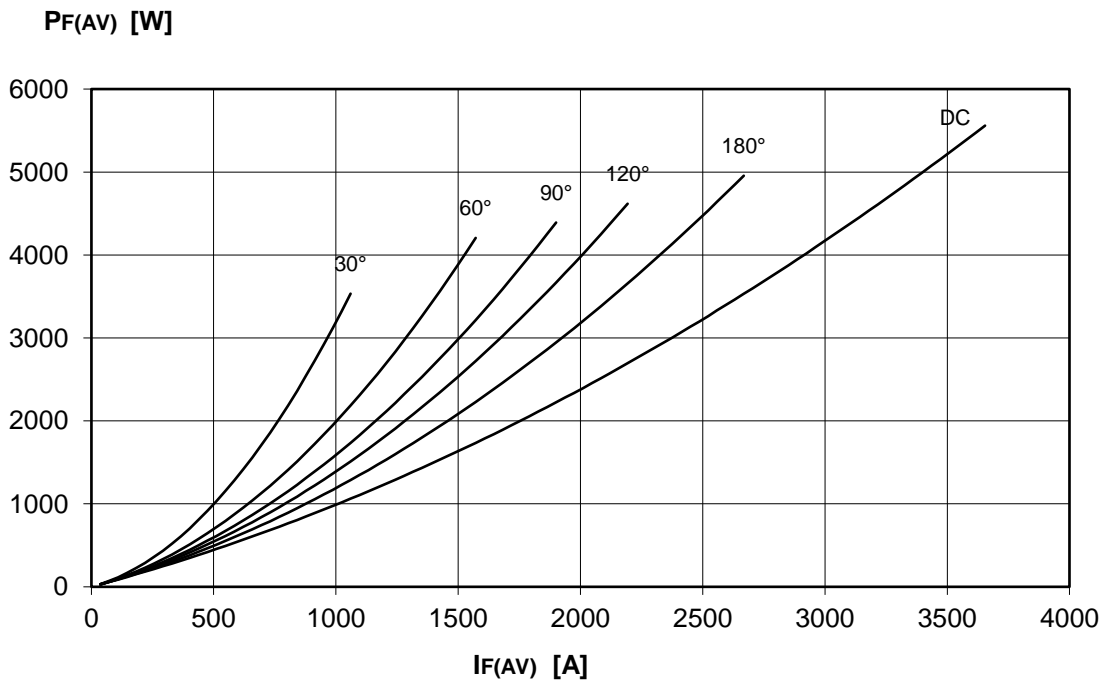
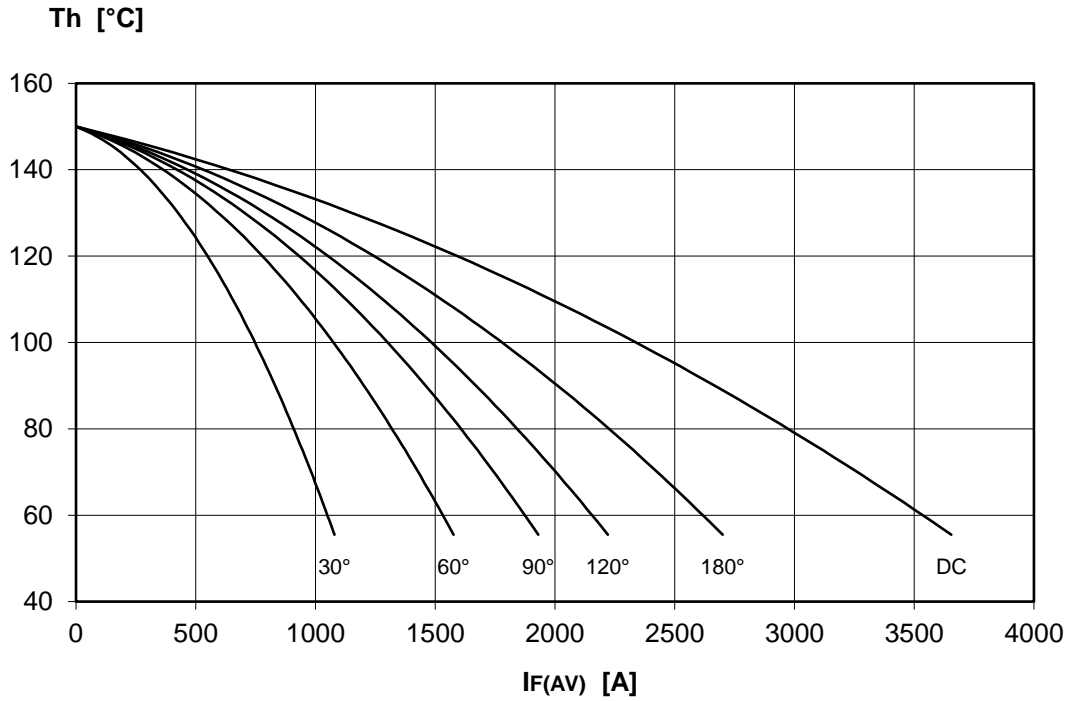

DISSIPATION CHARACTERISTICS

SINE WAVE

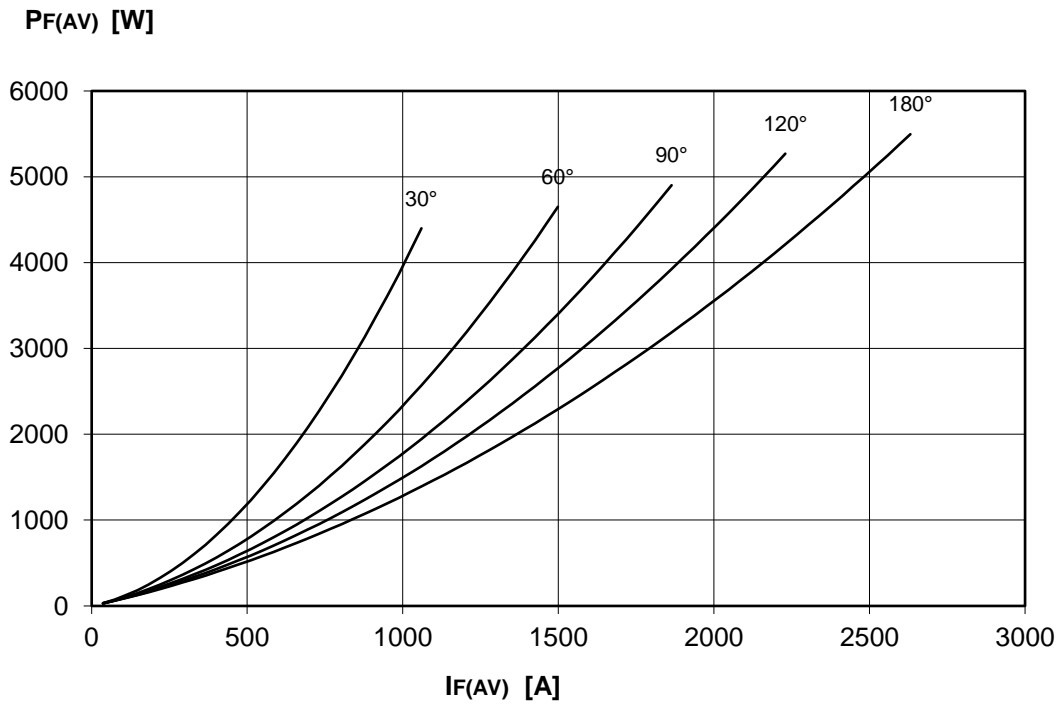
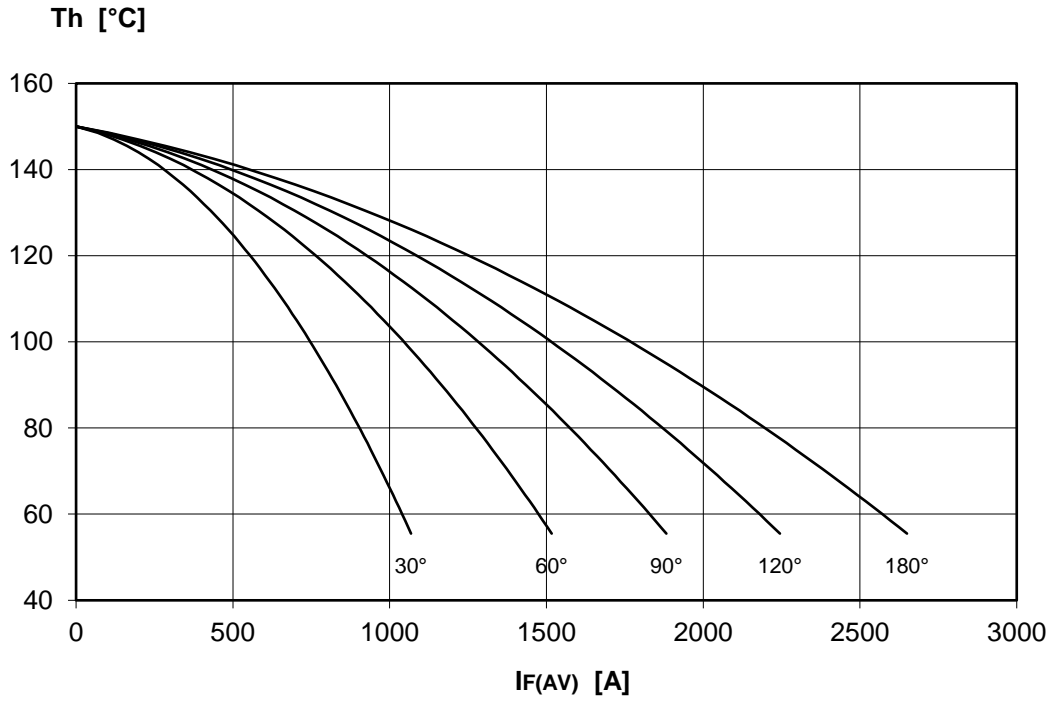

AR679HT RECTIFIER DIODE



FINAL SPECIFICATION Feb. 18 - Issue: 0

FORWARD CHARACTERISTIC
T_j = 150 °C

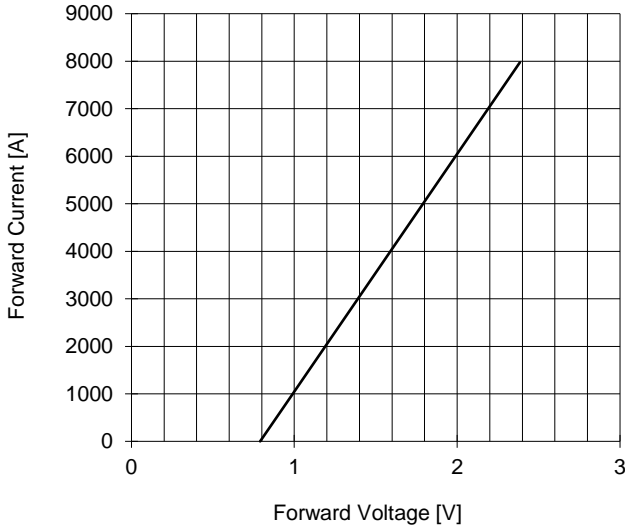

SURGE CHARACTERISTIC
T_j = 150 °C

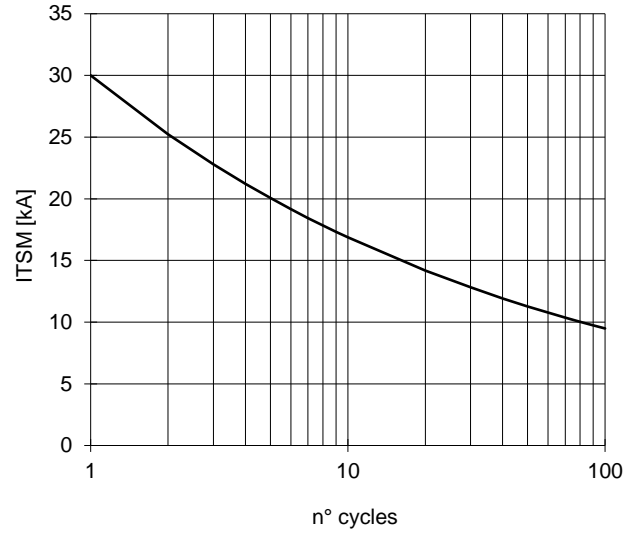

TRANSIENT THERMAL IMPEDANCE
DOUBLE SIDE COOLED

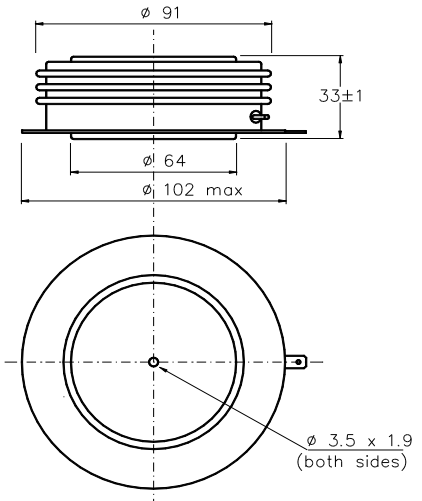
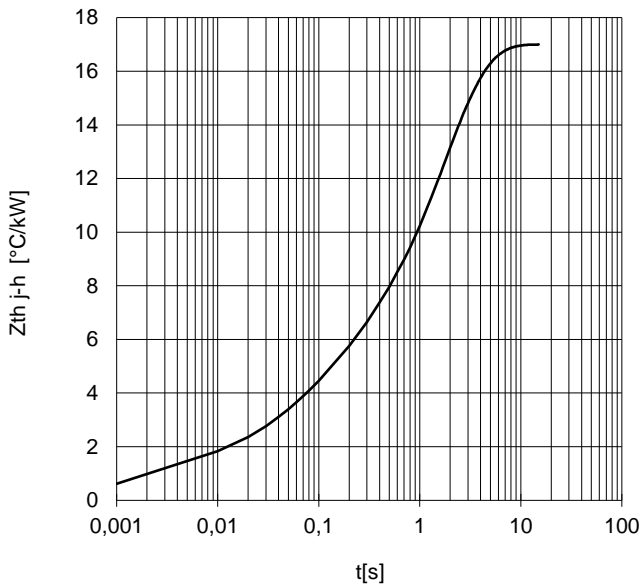

Dimensions
in mm

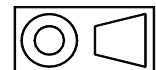

Distributed by

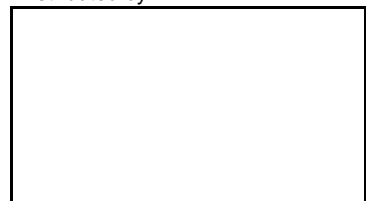

All the characteristics given in this data sheet are guaranteed only with uniform clamping force, cleaned and lubricated heatsink, surfaces with flatness < .03 mm and roughness < 2 μm. In the interest of product improvement POSEICO SpA reserves the right to change any data given in this data sheet at any time without previous notice. If not stated otherwise the maximum value of ratings (symbols over shaded background) and characteristics is reported.