

RECTIFIER DIODE

AR690

Repetitive voltage up to

6000 V

Mean forward current

2437 A

Surge current

18 kA
FINAL SPECIFICATION

Mar. 17 - Issue: 1

Symbol	Characteristic	Conditions	T _j [°C]	Value	Unit
BLOCKING					
V _{RRM}	Repetitive peak reverse voltage		150	6000	V
V _{RSM}	Non-repetitive peak reverse voltage		150	6100	V
I _{RRM}	Repetitive peak reverse current	V=VRRM	150	130	mA
CONDUCTING					
I _{F(AV)}	Mean forward current	180° sin, 50 Hz, Th=55°C, double side cooled		2437	A
I _{F(AV)}	Mean forward current	180° sin, 50 Hz, Tc=85°C, double side cooled		2240	A
I _{FSM}	Surge forward current	Sine wave, 10 ms without reverse voltage	150	18	kA
I ² t	I ² t			1620 x 10 ³	A ² s
V _{FM}	Forward voltage	Forward current = 2500 A	25	1,73	V
V _{F(TO)}	Threshold voltage		150	0,98	V
r _F	Forward slope resistance		150	0,30	mohm
SWITCHING					
t _{rr}	Reverse recovery time		150		μs
Q _{rr}	Reverse recovery charge				μC
I _{rr}	Peak reverse recovery current				A
MOUNTING					
R _{th(j-h)}	Thermal impedance, DC	Junction to heatsink, double side cooled		14,0	°C/kW
R _{th(c-h)}	Thermal impedance	Case to heatsink, double side cooled		3,0	°C/kW
T _j	Operating junction temperature			-30 / 150	°C
F	Mounting force			35.0 / 40.0	kN
	Mass			850	g
ORDERING INFORMATION : AR690 S 60 standard specification  VRRM/100					

DISSIPATION CHARACTERISTICS

SQUARE WAVE

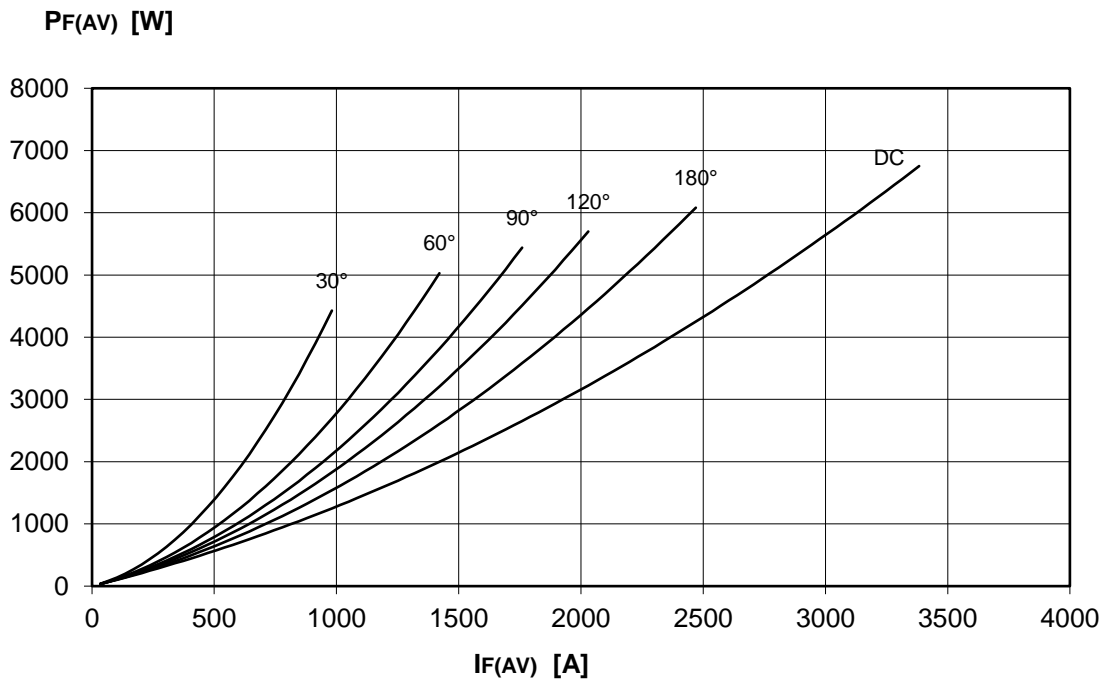
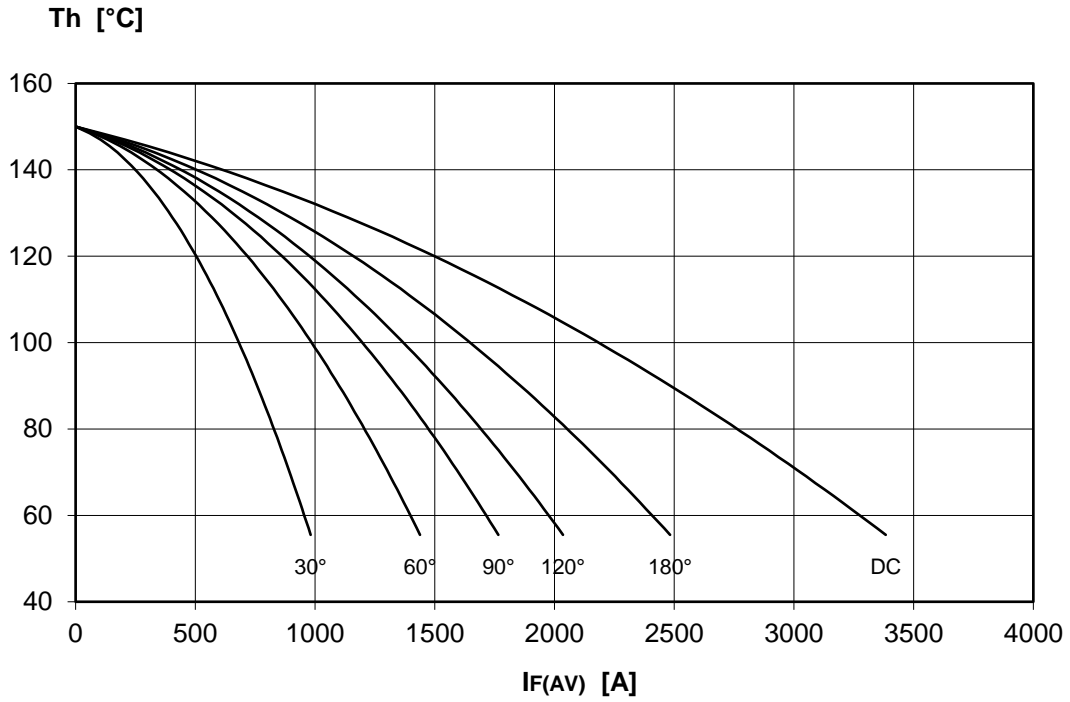

DISSIPATION CHARACTERISTICS

SINE WAVE

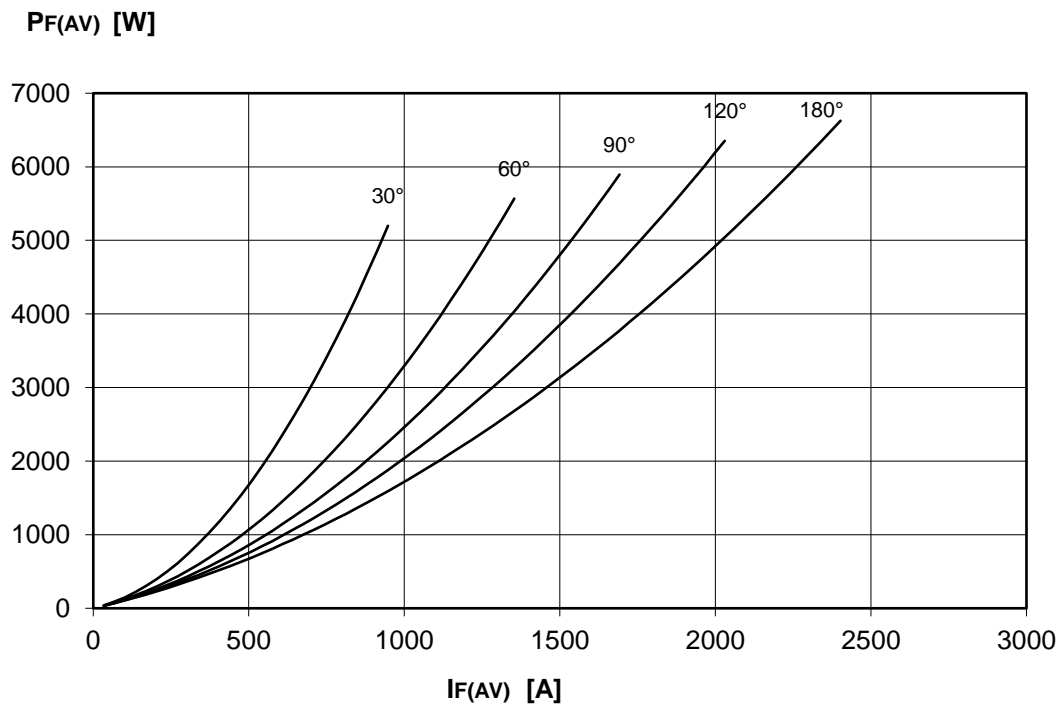
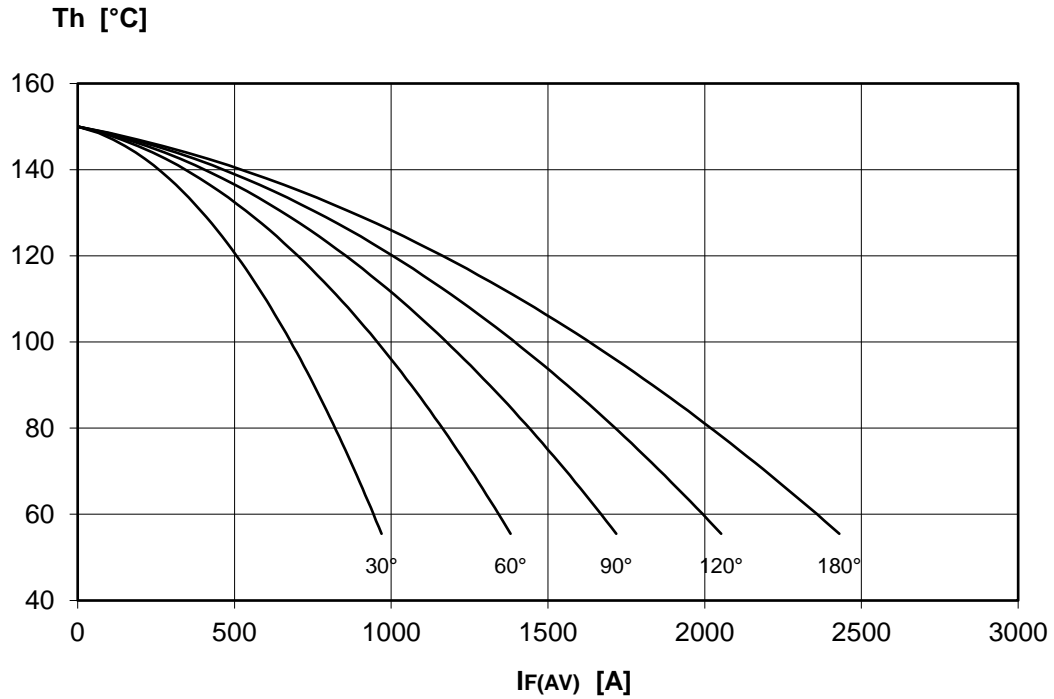

AR690 RECTIFIER DIODE



FINAL SPECIFICATION Mar. 17 - Issue: 1

FORWARD CHARACTERISTIC
T_j = 150 °C

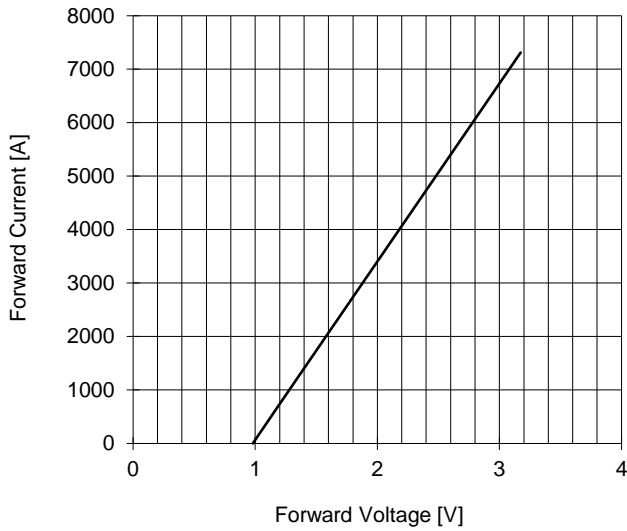

SURGE CHARACTERISTIC
T_j = 150 °C

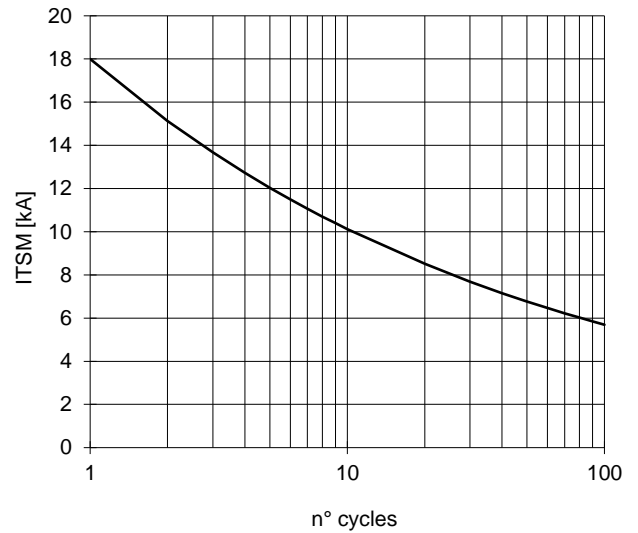

TRANSIENT THERMAL IMPEDANCE
DOUBLE SIDE COOLED

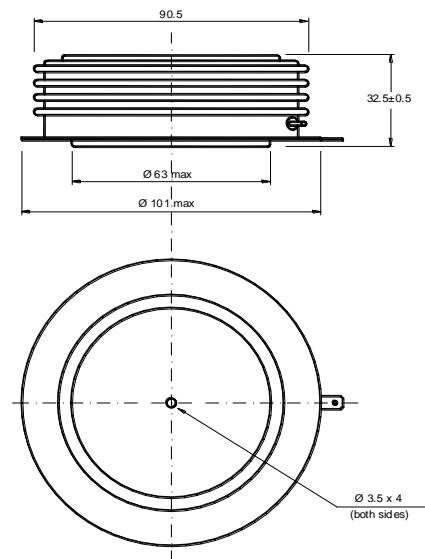
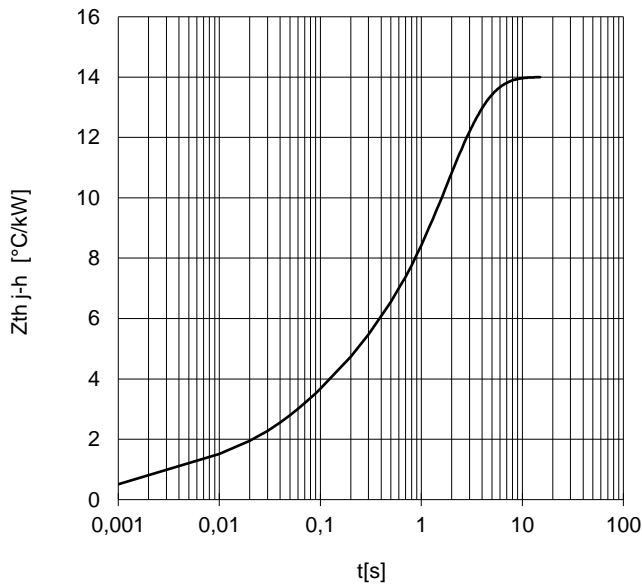

Dimensions
in mm



Distributed by

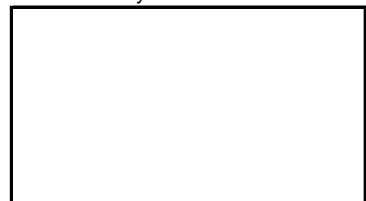

All the characteristics given in this data sheet are guaranteed only with uniform clamping force, cleaned and lubricated heatsink, surfaces with flatness < .03 mm and roughness < 2 μm.

In the interest of product improvement POSEICO SpA reserves the right to change any data given in this data sheet at any time without previous notice.

If not stated otherwise the maximum value of ratings (symbols over shaded background) and characteristics is reported.