

RECTIFIER DIODE

AR912

Repetitive voltage up to	5600 V
Mean forward current	645 A
Surge current	6,3 kA

FINAL SPECIFICATION

Mar. 17 - Issue: 6

Symbol	Characteristic	Conditions	T _j [°C]	Value	Unit
BLOCKING					
V _{RRM}	Repetitive peak reverse voltage		150	5600	V
V _{RSM}	Non-repetitive peak reverse voltage		150	5700	V
I _{RRM}	Repetitive peak reverse current	V=VRRM	150	50	mA
CONDUCTING					
I _{F(AV)}	Mean forward current	180° sin, 50 Hz, Th=55°C, double side cooled		645	A
I _{F(AV)}	Mean forward current	180° sin, 50 Hz, Tc=85°C, double side cooled		583	A
I _{FSM}	Surge forward current	Sine wave, 10 ms without reverse voltage	150	6,3	kA
I ² t	I ² t			198 x 10 ³	A ² s
V _{FM}	Forward voltage	Forward current = 1200 A	25	2,10	V
V _{F(TO)}	Threshold voltage		150	1,00	V
r _F	Forward slope resistance		150	1,150	mohm
SWITCHING					
t _{rr}	Reverse recovery time		150		μs
Q _{rr}	Reverse recovery charge				μC
I _{rr}	Peak reverse recovery current				A
MOUNTING					
R _{th(j-h)}	Thermal impedance, DC	Junction to heatsink, double side cooled		52,0	°C/kW
R _{th(c-h)}	Thermal impedance	Case to heatsink, double side cooled		10,0	°C/kW
T _j	Operating junction temperature			-30 / 150	°C
F	Mounting force			8.4 / 9.4	kN
	Mass			280	g
ORDERING INFORMATION : AR912 S 56 standard specification  VRRM/100					

DISSIPATION CHARACTERISTICS

SQUARE WAVE

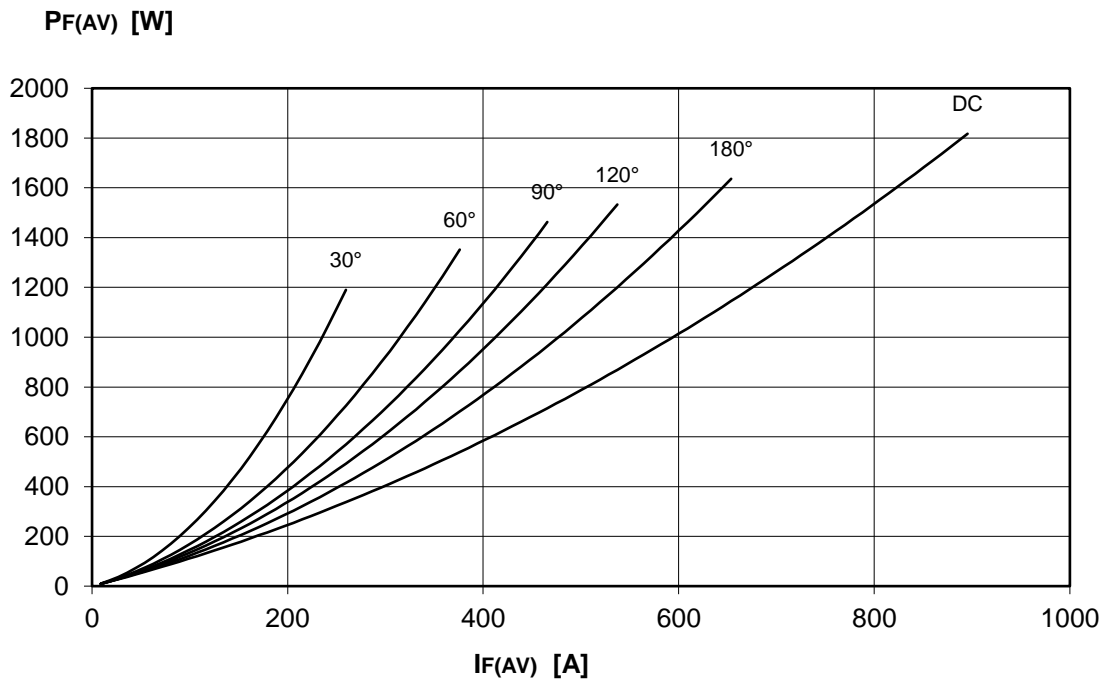
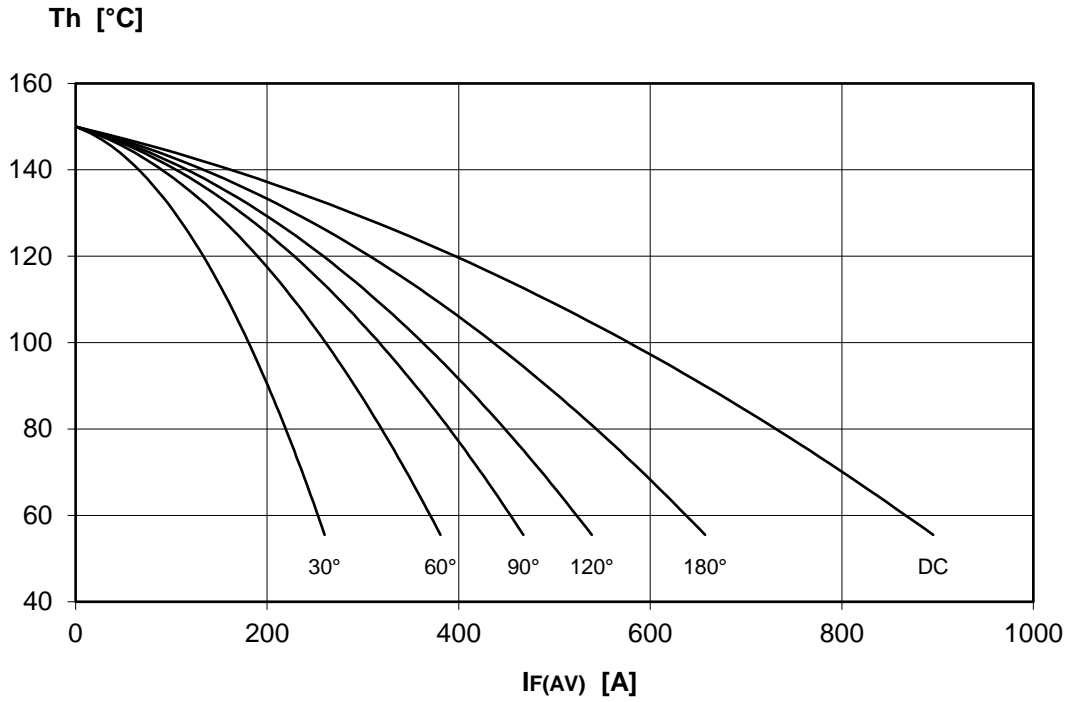

DISSIPATION CHARACTERISTICS

SINE WAVE

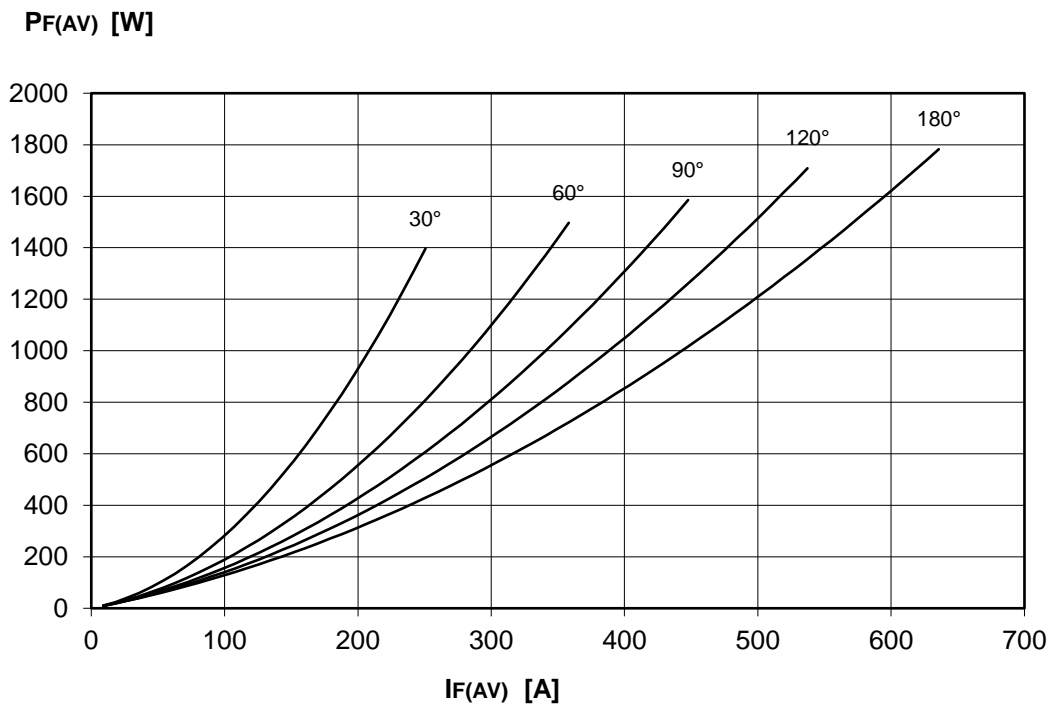
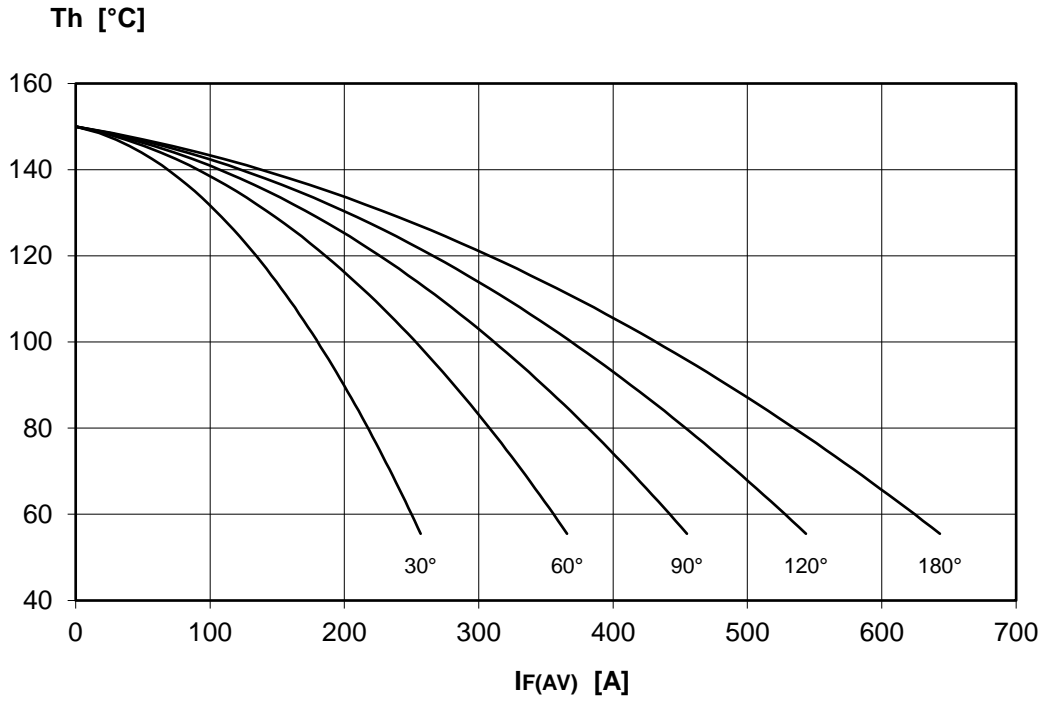

AR912 RECTIFIER DIODE



FINAL SPECIFICATION Mar. 17 - Issue: 6

FORWARD CHARACTERISTIC
T_j = 150 °C

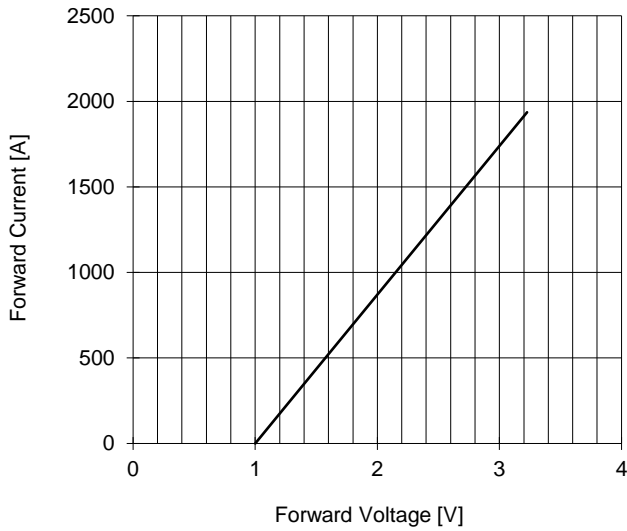

SURGE CHARACTERISTIC
T_j = 150 °C

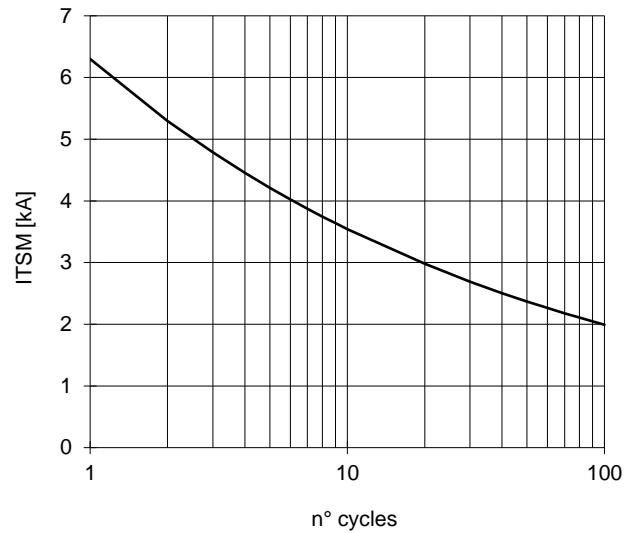

TRANSIENT THERMAL IMPEDANCE
DOUBLE SIDE COOLED

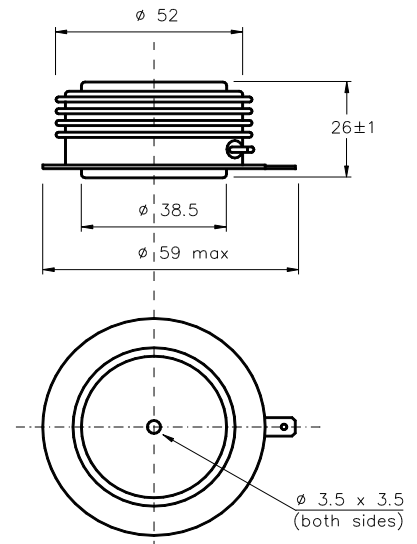
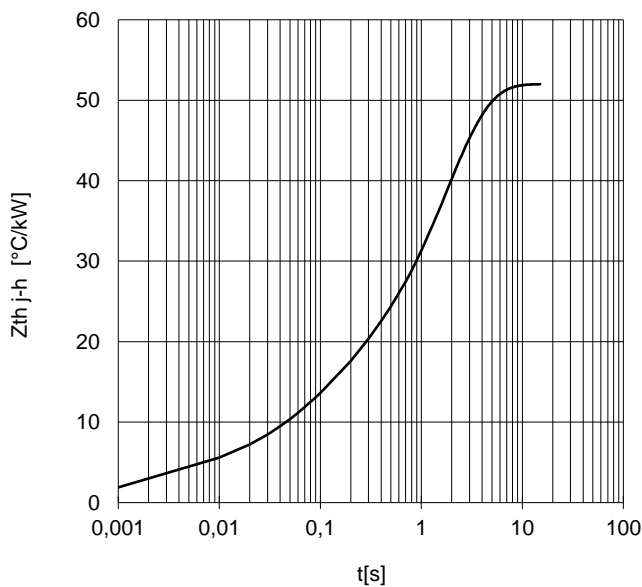

Dimensions
in mm



Distributed by

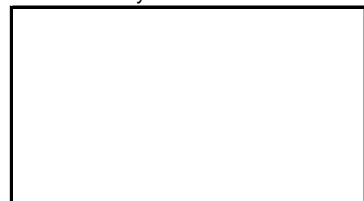

All the characteristics given in this data sheet are guaranteed only with uniform clamping force, cleaned and lubricated heatsink, surfaces with flatness < .03 mm and roughness < 2 μm.

In the interest of product improvement POSEICO SpA reserves the right to change any data given in this data sheet at any time without previous notice.

If not stated otherwise the maximum value of ratings (symbols over shaded background) and characteristics is reported.