

## PHASE CONTROL MODULE

# ATT621

Repetitive voltage up to

**1600 V**

Mean forward current

**620 A**

Surge current

**15 kA**

### FINAL SPECIFICATION

apr 17 - ISSUE : 02

Symbol	Characteristic	Conditions	T <sub>j</sub> [°C]	Value	Unit
<b>BLOCKING</b>					
V <sub>RRM</sub>	Repetitive peak reverse/off-state voltage		135	1600	V
V <sub>RSM</sub>	Non-repetitive peak reverse voltage		135	1700	V
I <sub>RRM/DRM</sub>	Repetitive peak reverse/off-state current		135	50	mA
<b>CONDUCTING</b>					
I <sub>T(AV)</sub>	Mean forward current	180° sin, 50 Hz, Th=91°C, single side cooled		620	A
I <sub>T(AV)</sub>	Mean forward current	180° sin, 50 Hz, Tc=55°C, single side cooled		945	A
I <sub>TSM</sub>	Surge forward current	Sine wave, 10 ms	135	15	kA
I <sup>2</sup> t	I <sup>2</sup> t	without reverse voltage		1125 x 10 <sup>3</sup>	A <sup>2</sup> s
V <sub>T</sub>	On-state voltage	On-state current = 1600 A	25	1,50	V
V <sub>T(TO)</sub>	Threshold voltage		135	0,90	V
r <sub>T</sub>	On-state slope resistance		135	0,340	mohm
<b>SWITCHING</b>					
di/dt	Critical rate of rise of on-state current, min.	From 75% VDRM up to 1050 A; gate 10V, 5Ω	135	200	A/μs
dv/dt	Critical rate of rise of off-state voltage, min.	Linear ramp up to 70% of VDRM	135	500	V/μs
t <sub>d</sub>	Gate controlled delay time, typical	VD=100V; gate source 25V, 10Ω, tr=.5 μs	25	1,1	μs
t <sub>q</sub>	Circuit commutated turn-off time, typical	dv/dt = 20 V/μs linear up to 75% VDRM		200	μs
Q <sub>rr</sub>	Reverse recovery charge	di/dt = -20 A/μs, I= 700 A	135		μC
I <sub>rr</sub>	Peak reverse recovery current	VR= 50 V			A
I <sub>H</sub>	Holding current, typical	VD=5V, gate open circuit	25	300	mA
I <sub>L</sub>	Latching current, typical	VD=5V, tp=30μs	25	700	mA
<b>GATE</b>					
V <sub>GT</sub>	Gate trigger voltage	VD=5V	25	3,50	V
I <sub>GT</sub>	Gate trigger current	VD=5V	25	250	mA
V <sub>GD</sub>	Non-trigger gate voltage, min.	VD=VDRM	135	0,25	V
V <sub>FGM</sub>	Peak gate voltage (forward)			30	V
I <sub>FGM</sub>	Peak gate current			10	A
V <sub>RGM</sub>	Peak gate voltage (reverse)			5	V
P <sub>GM</sub>	Peak gate power dissipation	Pulse width 100 μs		150	W
P <sub>G</sub>	Average gate power dissipation			2	W
<b>MOUNTING</b>					
R <sub>th(j-c)</sub>	Thermal impedance, DC	Junction to case, per element		50,0	°C/kW
R <sub>th(c-h)</sub>	Thermal impedance	Case to heatsink, per element		20,0	°C/kW
T <sub>j</sub>	Operating junction temperature			-30 / 135	°C
V <sub>ins</sub>	RMS insulation voltage	50 hz, circuit to base, all terminal shorted	25	4500	V
T	Mounting torque	Case to heatsink		4 to 6	Nm
T	Mounting torque	Busbars to terminal		12 to 18	Nm
	Mass			1500	g

### ORDERING INFORMATION : ATT621 S 16

standard specification   VRRM/100

FINAL SPECIFICATION apr 17 - ISSUE : 02

## DISSIPATION CHARACTERISTICS

### SQUARE WAVE

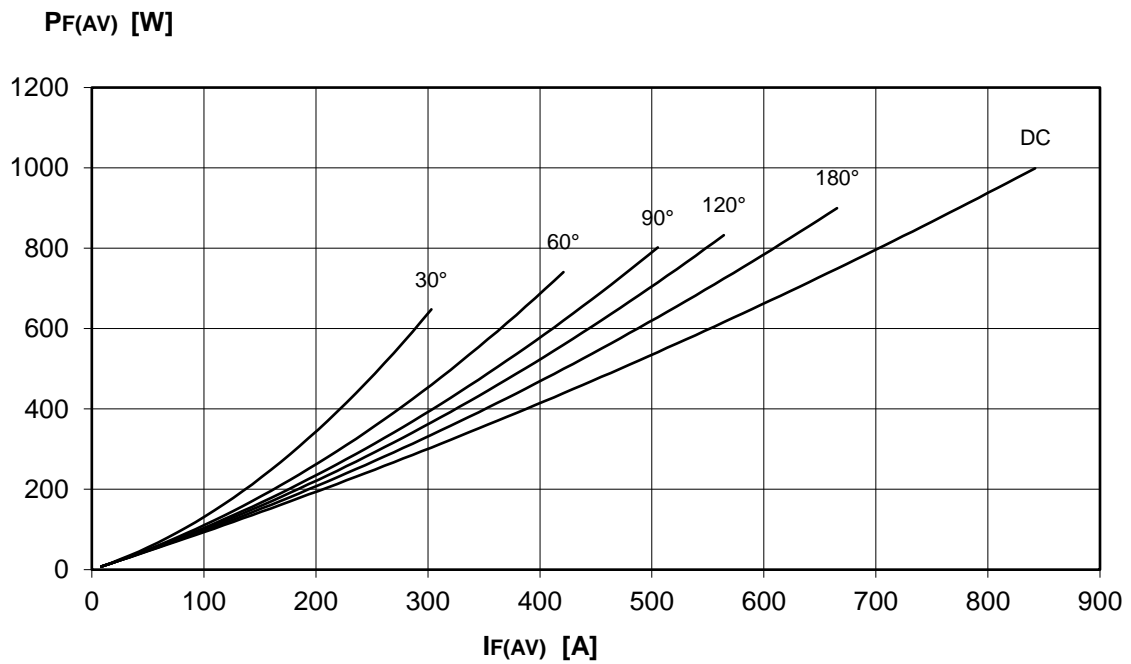
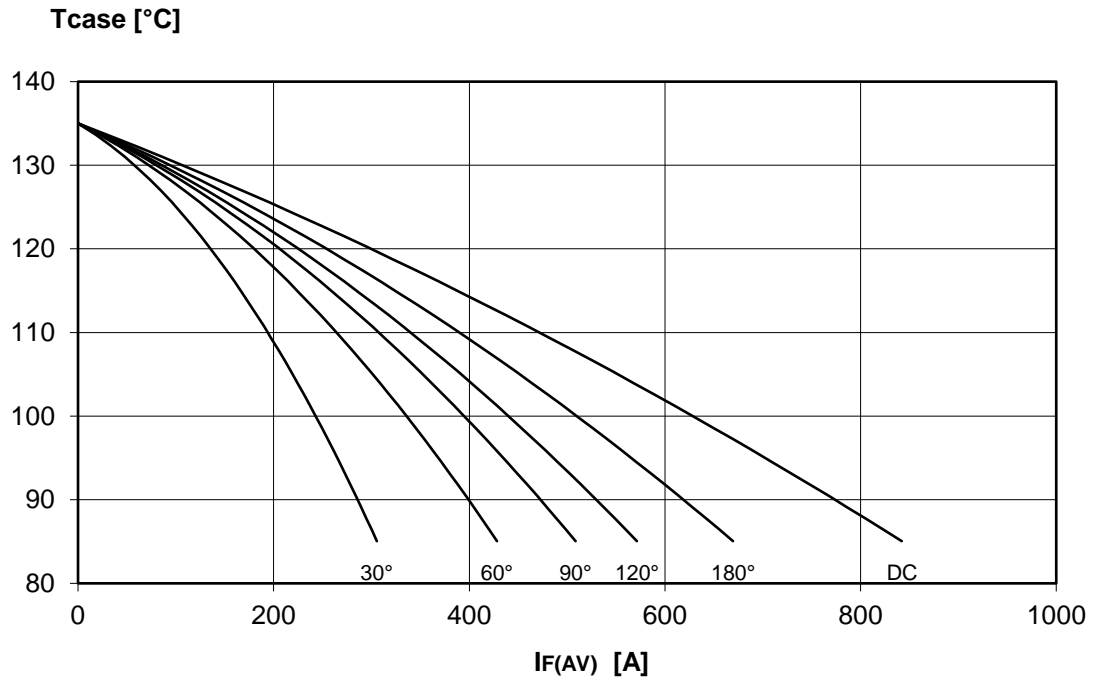

FINAL SPECIFICATION apr 17 - ISSUE : 02

**DISSIPATION CHARACTERISTICS**

SINE WAVE

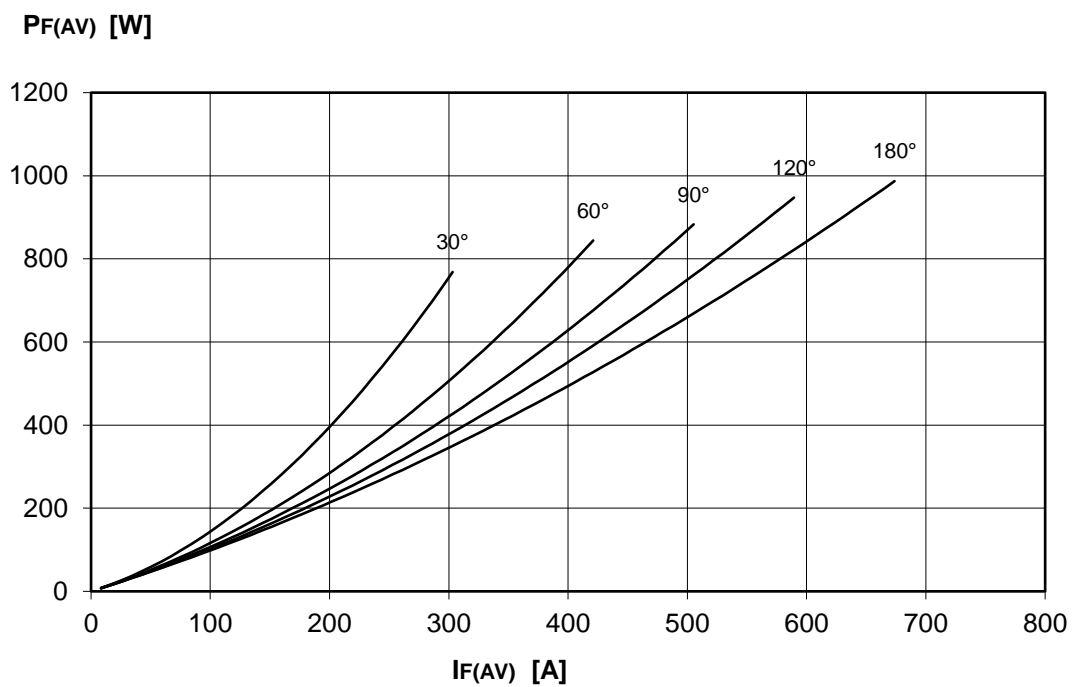
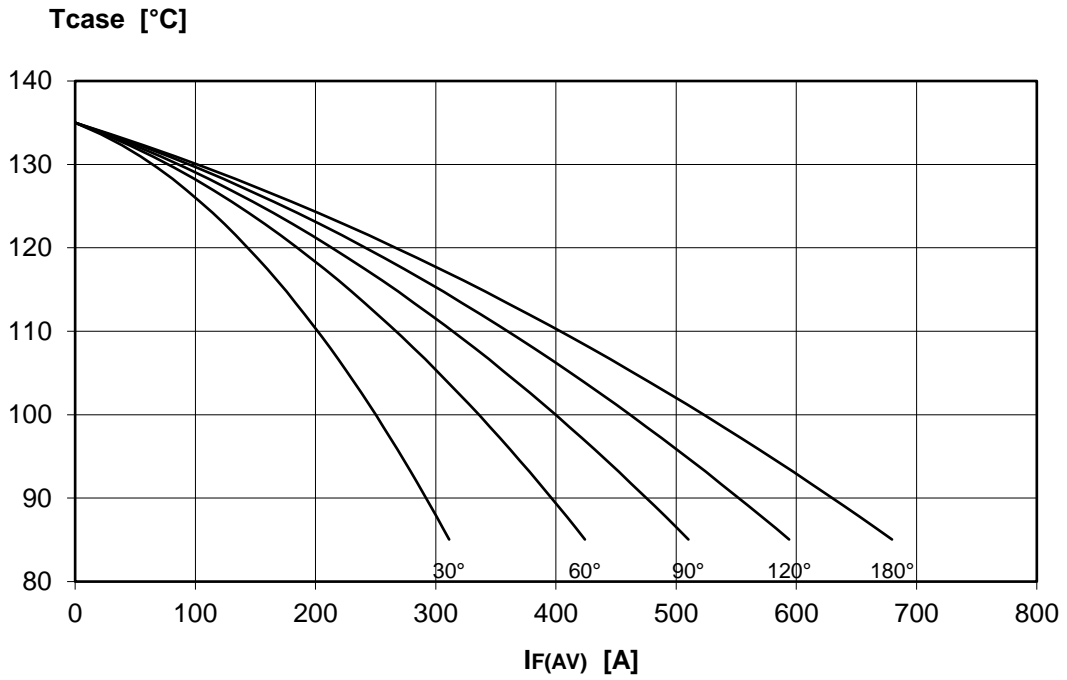

FINAL SPECIFICATION apr 17 - ISSUE : 02

ON-STATE CHARACTERISTIC  
T<sub>j</sub> = 135 °C

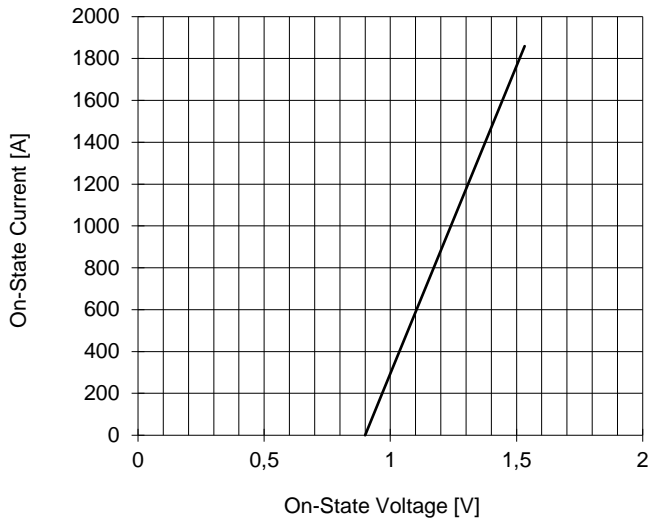

SURGE CHARACTERISTIC  
T<sub>j</sub> = 135 °C

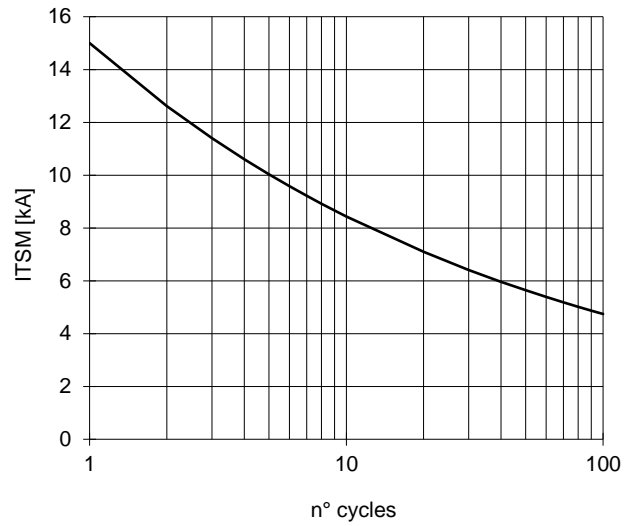

TRANSIENT THERMAL IMPEDANCE

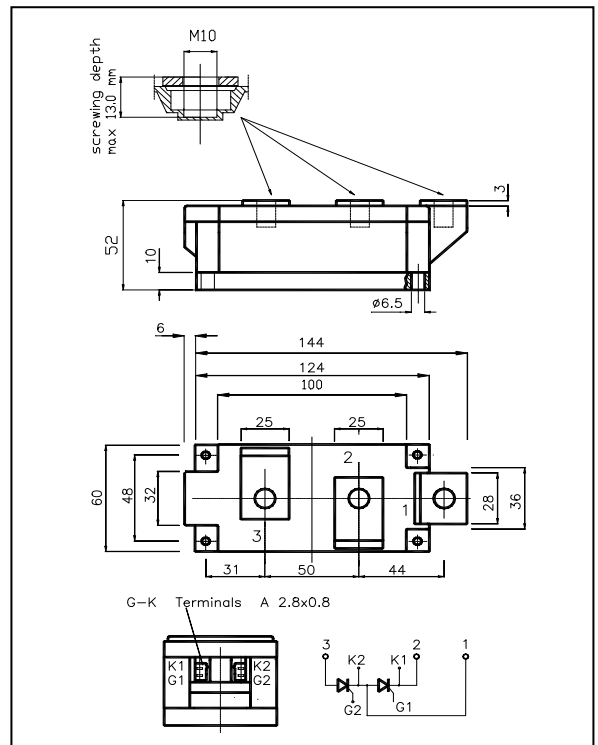
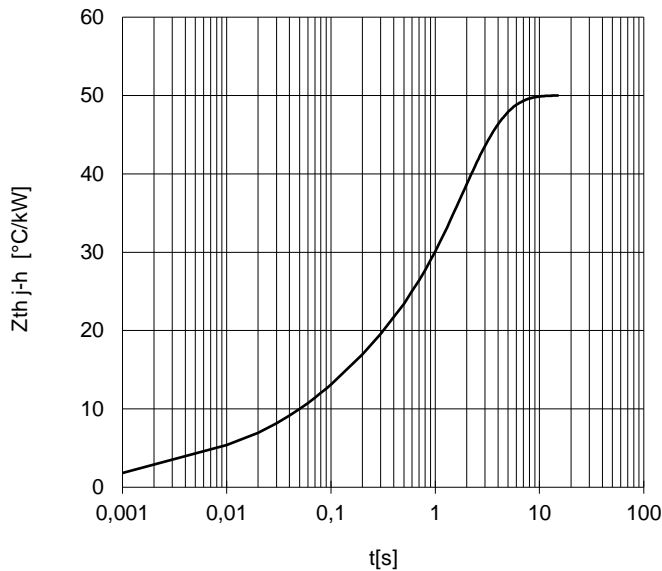

All the characteristics given in this data sheet are guaranteed only with uniform clamping force, cleaned and lubricated heatsink, surfaces with flatness < .03 mm and roughness < 2 μm. In the interest of product improvement POSEICO SpA reserves the right to change any data given in this data sheet at any time without previous notice. If not stated otherwise the maximum value of ratings (symbols over shaded background) and characteristics is reported.

Distributed by

