

RECTIFIER DIODES MODULE

ADD905

Repetitive voltage up to **1200 V**
Mean forward current **837 A**
Surge current **24 kA**

FINAL SPECIFICATION

Apr. 17 - Issue: 1

Symbol	Characteristic	Conditions	T _j [°C]	Value	Unit
BLOCKING					
V _{RRM}	Repetitive peak reverse voltage		150	1200	V
V _{RSM}	Non-repetitive peak reverse voltage		150	1300	V
I _{RRM}	Repetitive peak reverse current	V=VRRM	150	50	mA
CONDUCTING					
I _{F(AV)}	Mean forward current	180° sin, 50 Hz, T _c =100°C, single side cooled		679	A
I _{F(AV)}	Mean forward current	180° sin, 50 Hz, T _c =85°C, single side cooled		837	A
I _{FSM}	Surge forward current	Sine wave, 10 ms without reverse voltage	150	24	kA
I ² t	I ² t			2880 x 10 ³	A ² s
V _{FM}	Forward voltage		150	0,80	V
V _{F(TO)}	Threshold voltage		150	0,80	V
r _F	Forward slope resistance		150	0,150	mohm
SWITCHING					
t _{rr}	Reverse recovery time		150		μs
Q _{rr}	Reverse recovery charge				μC
I _{rr}	Peak reverse recovery current				A
MOUNTING					
R _{th(j-c)}	Thermal impedance, DC	Junction to case, per element		70,0	°C/kW
R _{th(c-h)}	Thermal impedance	Case to heatsink, per element		20,0	°C/kW
T _j	Operating junction temperature			-30 / 150	°C
V _{ins}	RMS insulation voltage	50Hz, 1min, circuit to base,all terminal shorted	25	2500	V
T	Mounting torque	Case to heatsink		4 to 6	Nm
		Busbars to terminals		9 to 11	Nm
	Mass			1500	g

ORDERING INFORMATION : ADD905 S 12

standard specification VRRM/100

DISSIPATION CHARACTERISTICS

SQUARE WAVE

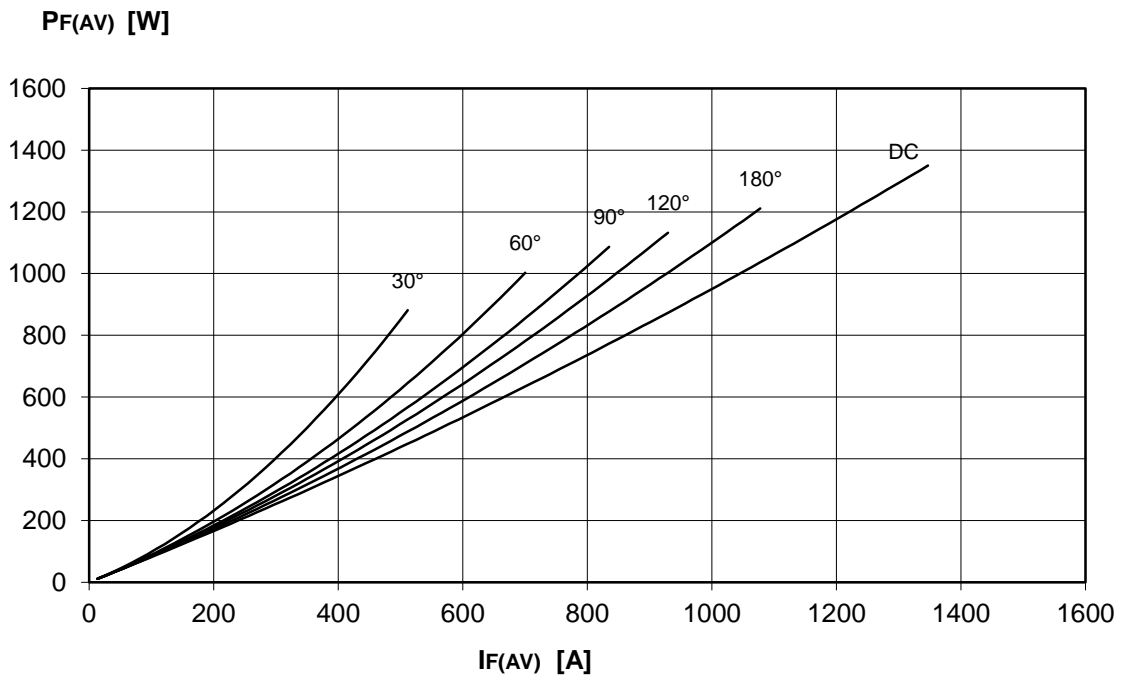
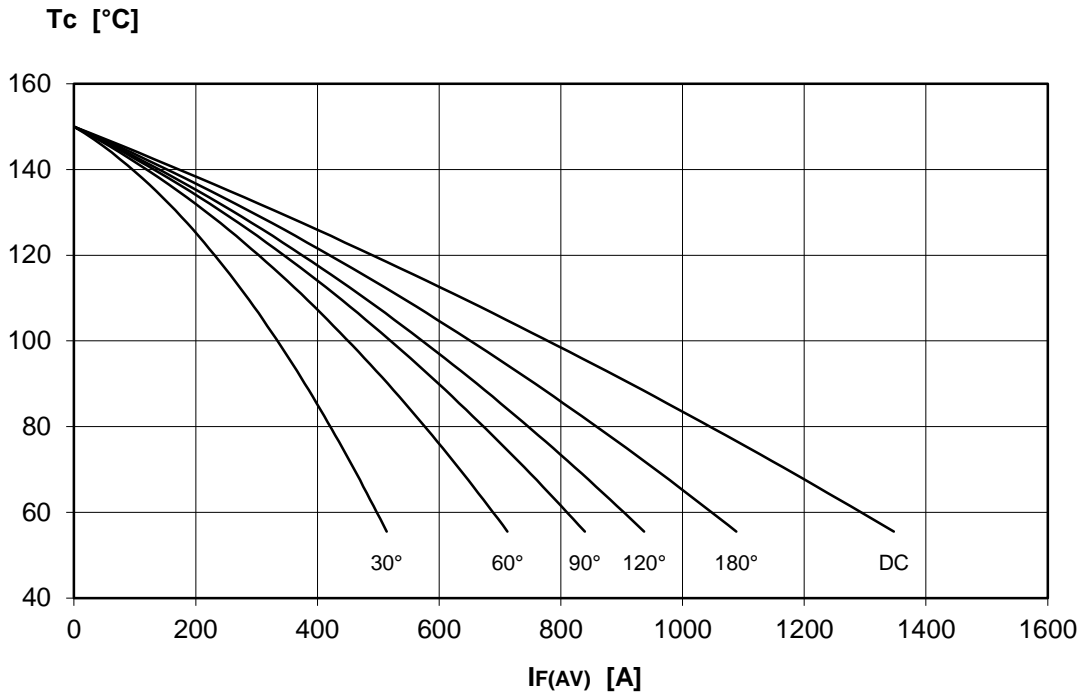

DISSIPATION CHARACTERISTICS

SINE WAVE

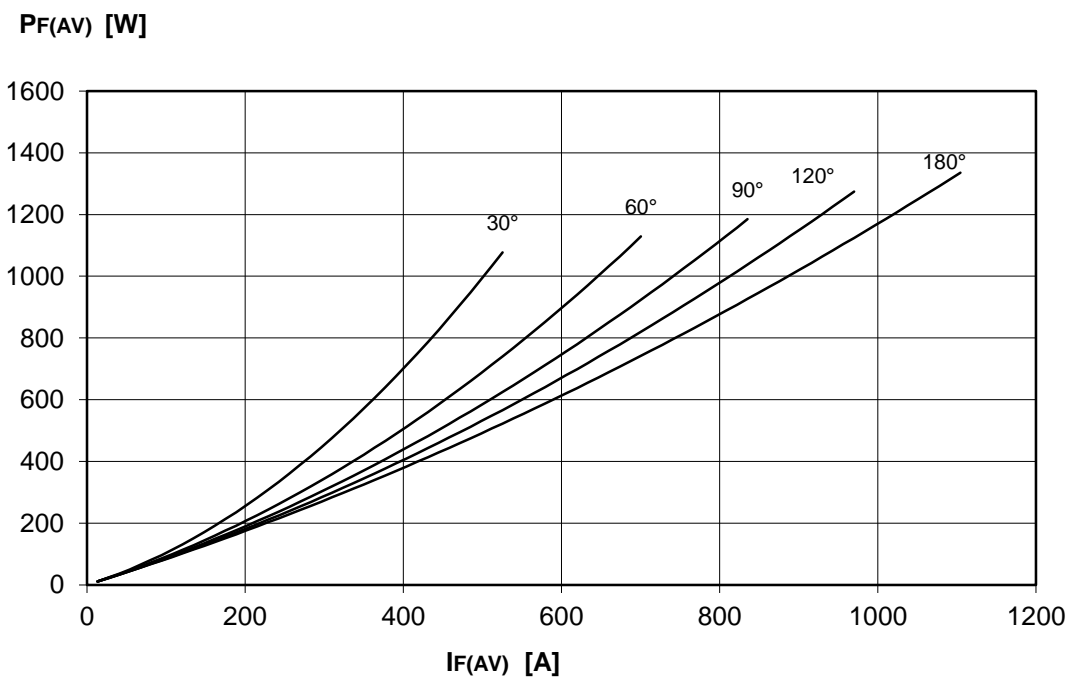
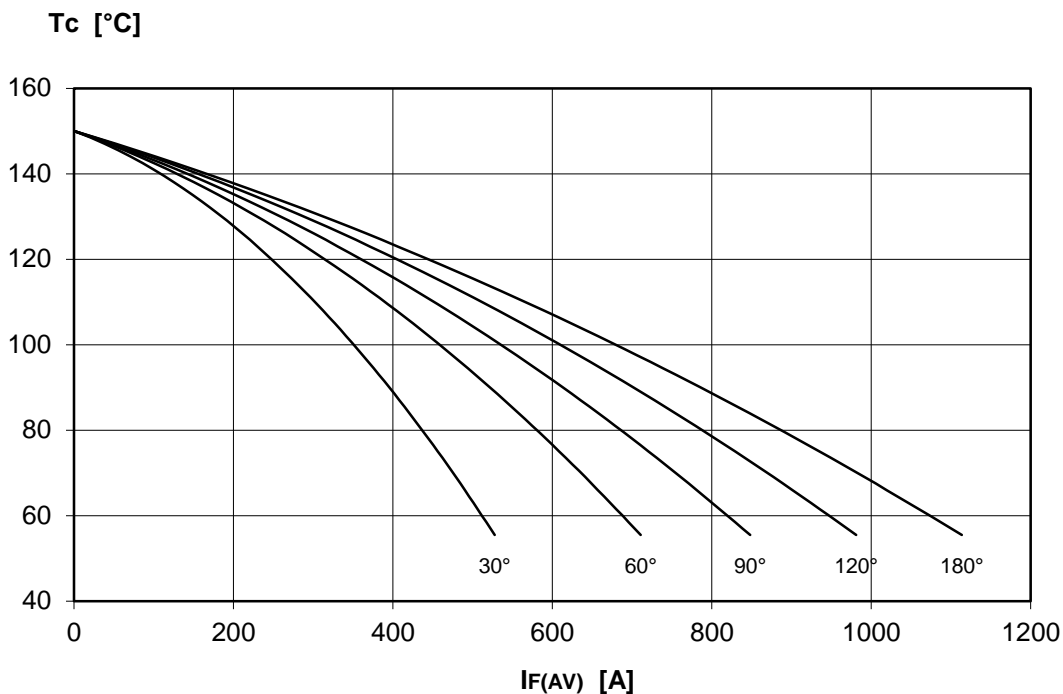

FORWARD CHARACTERISTIC
T_j = 150 °C

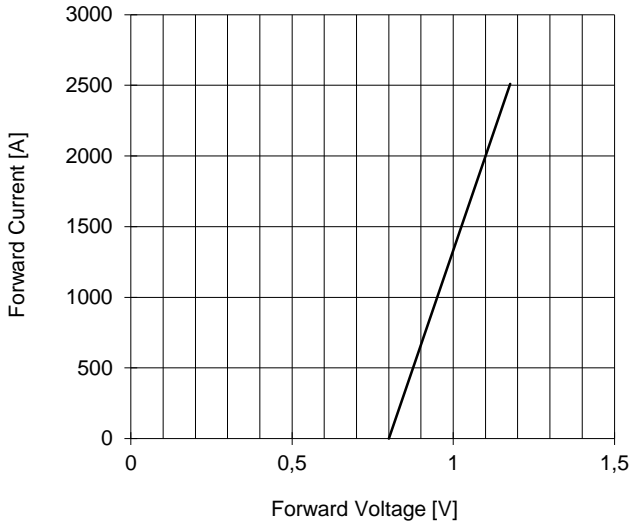

SURGE CHARACTERISTIC
T_j = 150 °C

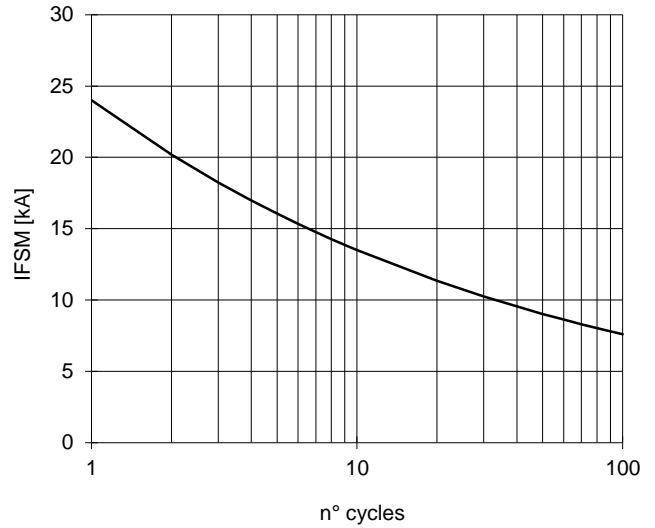

TRANSIENT THERMAL IMPEDANCE

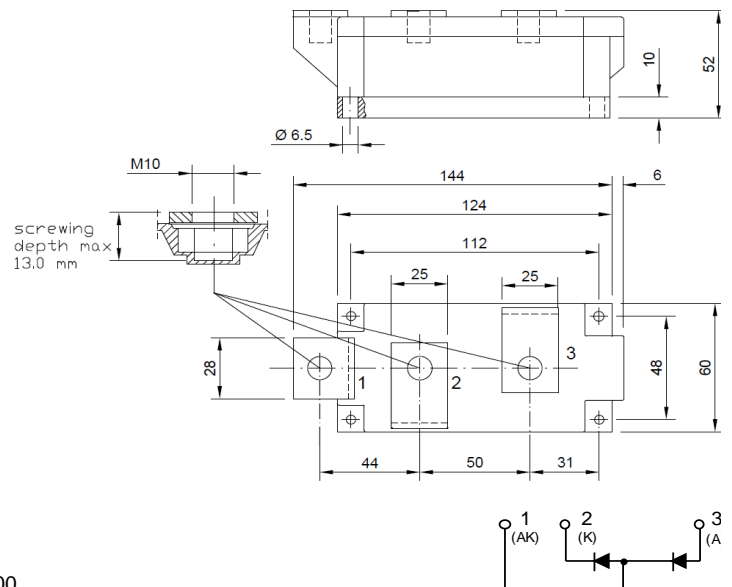
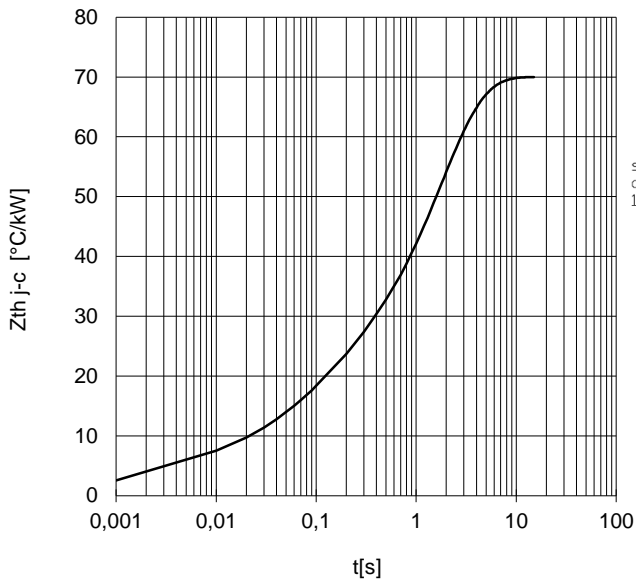

Distributed by

All the characteristics given in this data sheet are guaranteed only with uniform clamping force, cleaned and lubricated heatsink, surfaces with flatness < .03 mm and roughness < 2 μm.
In the interest of product improvement POSEICO SpA reserves the right to change any data given in this data sheet at any time without previous notice.
If not stated otherwise the maximum value of ratings (symbols over shaded background) and characteristics is reported.

