

**RECTIFIER DIODE**

# AR3001LT

Repetitive voltage up to	<b>1000 V</b>
Mean forward current	<b>6457 A</b>
Surge current	<b>50,4 kA</b>

**FINAL SPECIFICATION**

Mar. 17 - Issue: 4

Symbol	Characteristic	Conditions	T <sub>j</sub> [°C]	Value	Unit
<b>BLOCKING</b>					
V <sub>RRM</sub>	Repetitive peak reverse voltage		190	1000	V
V <sub>RSM</sub>	Non-repetitive peak reverse voltage		190	1100	V
I <sub>RRM</sub>	Repetitive peak reverse current	V=VRRM	190	75	mA
<b>CONDUCTING</b>					
I <sub>F(AV)</sub>	Mean forward current	180° sin, 50 Hz, Th=85°C, double side cooled		6457	A
I <sub>F(AV)</sub>	Mean forward current	180° sin, 50 Hz, Tc=55°C, double side cooled		11610	A
I <sub>FSM</sub>	Surge forward current	Sine wave, 10 ms without reverse voltage	190	50,4	kA
I <sup>2</sup> t	I <sup>2</sup> t			12701 x 10 <sup>3</sup>	A <sup>2</sup> s
V <sub>FM</sub>	Forward voltage	Forward current = 4500 A	25	1,16	V
V <sub>F(TO)</sub>	Threshold voltage		190	0,75	V
r <sub>F</sub>	Forward slope resistance		190	0,055	mohm
<b>SWITCHING</b>					
t <sub>rr</sub>	Reverse recovery time		190		μs
Q <sub>rr</sub>	Reverse recovery charge				μC
I <sub>rr</sub>	Peak reverse recovery current				A
<b>MOUNTING</b>					
R <sub>th(j-c)</sub>	Thermal impedance, DC	Junction to case, double side cooled		10,0	°C/kW
R <sub>th(c-h)</sub>	Thermal impedance	Case to heatsink, double side cooled		5,0	°C/kW
T <sub>j</sub>	Operating junction temperature			-30 / 190	°C
F	Mounting force			22,0 / 24,5	kN
	Mass			200	g
<b>ORDERING INFORMATION : AR3001LT S 10</b> standard specification <input type="checkbox"/> <input type="checkbox"/> VRRM/100					

**DISSIPATION CHARACTERISTICS**

SQUARE WAVE

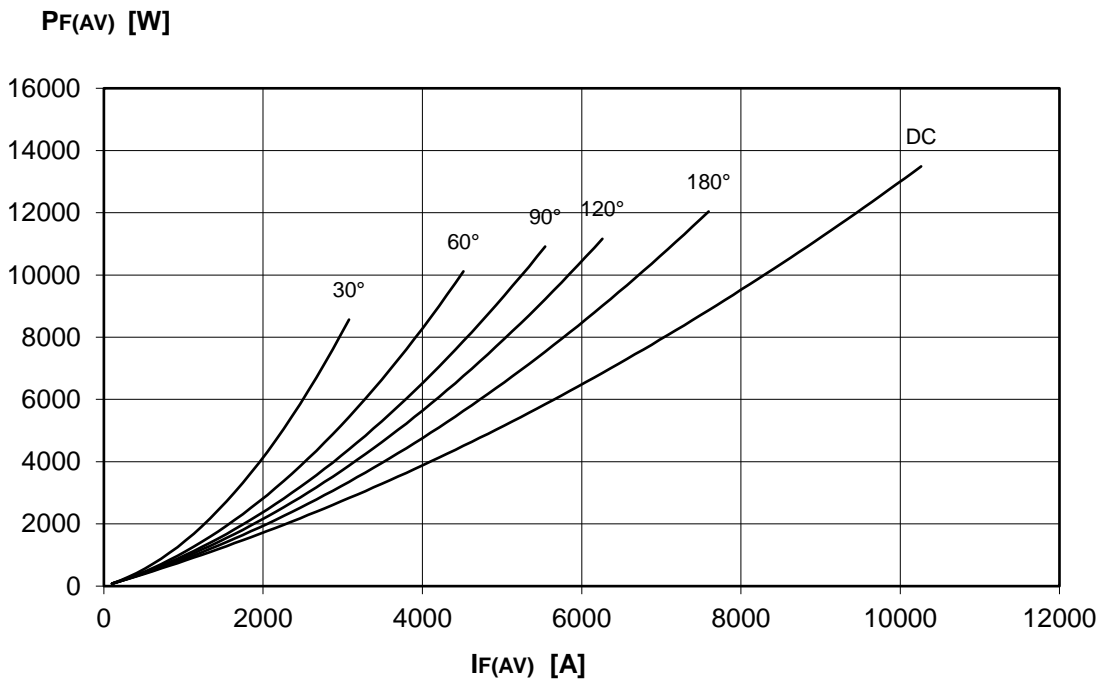
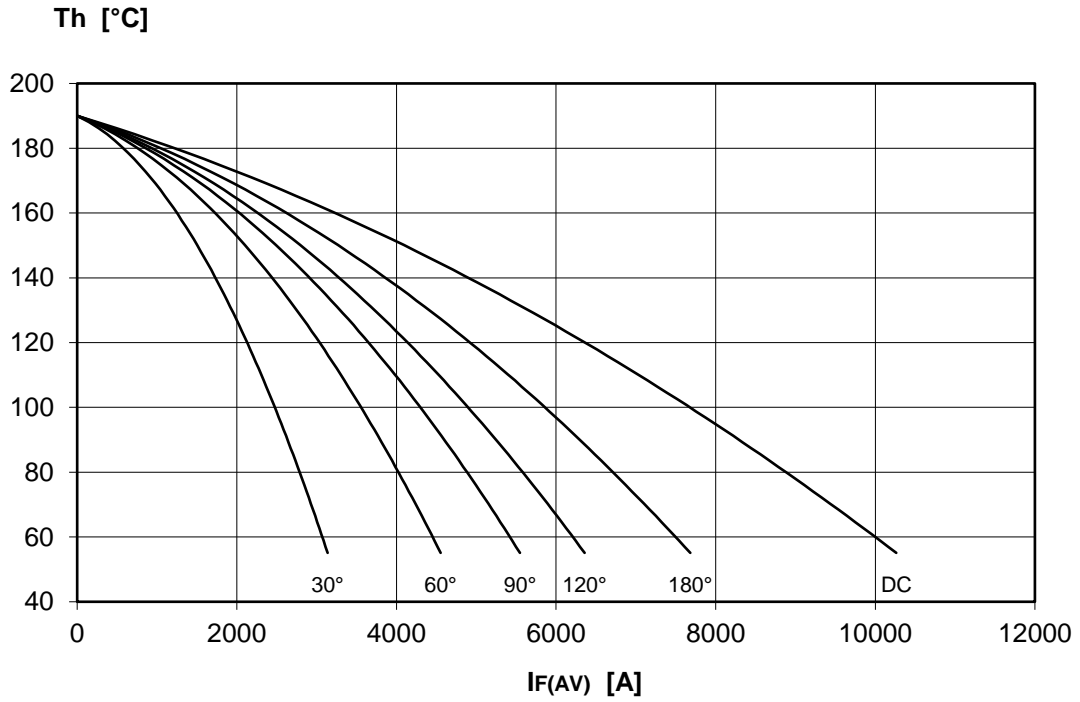

**DISSIPATION CHARACTERISTICS**

SINE WAVE

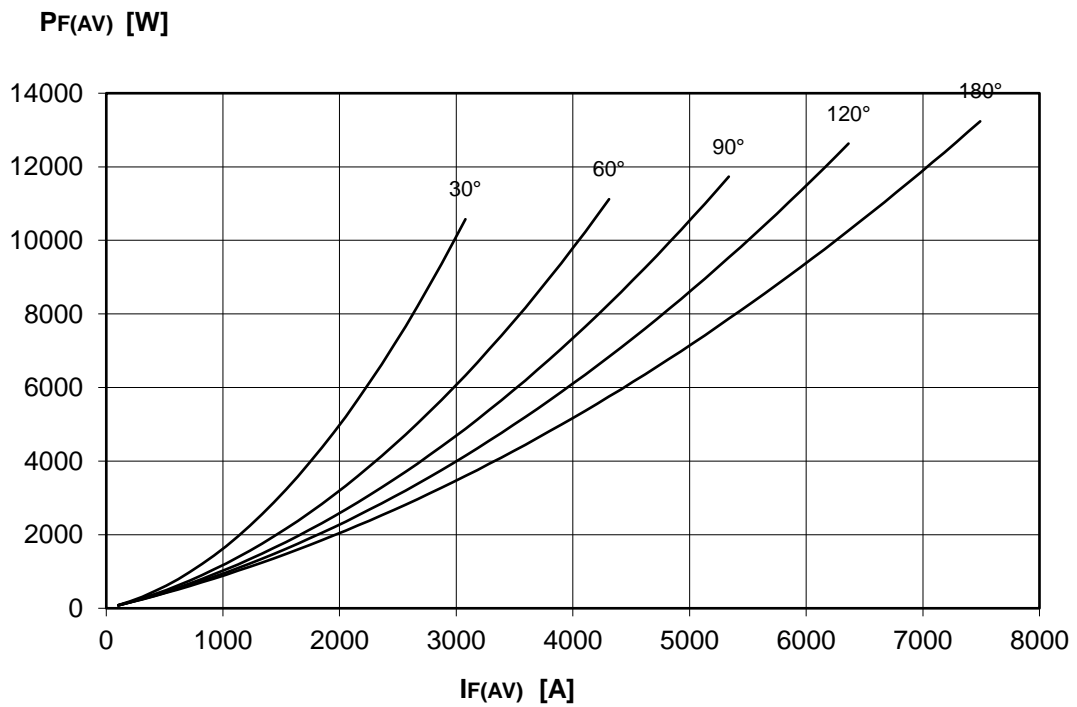
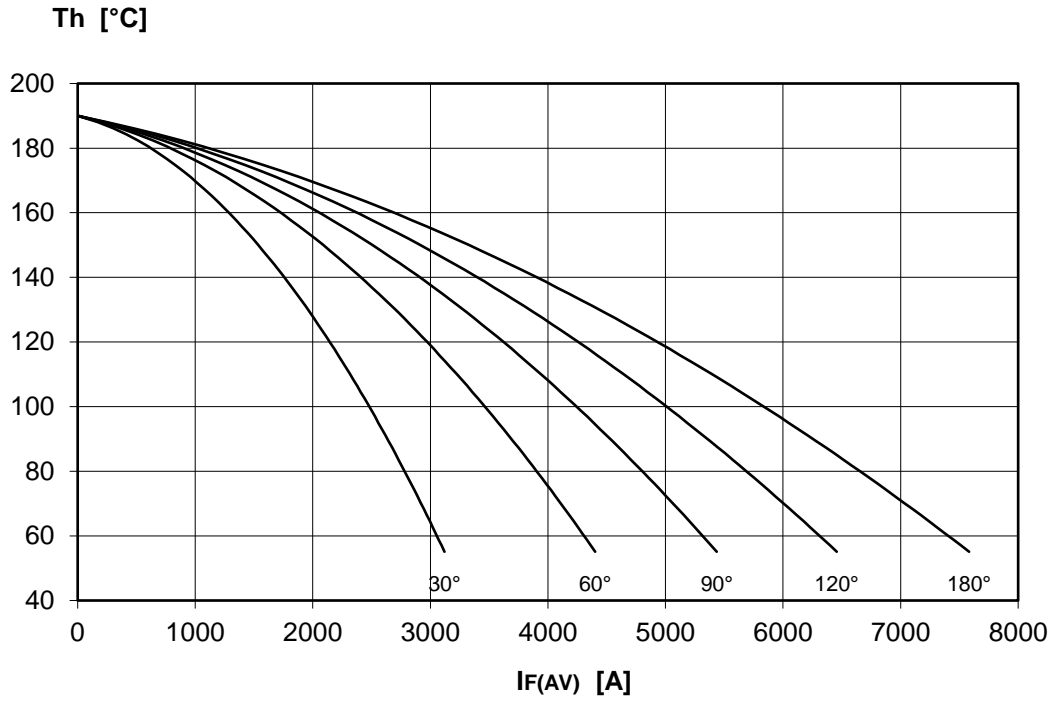

# AR3001LT RECTIFIER DIODE



FINAL SPECIFICATION Mar. 17 - Issue: 4

FORWARD CHARACTERISTIC  
T<sub>j</sub> = 190 °C

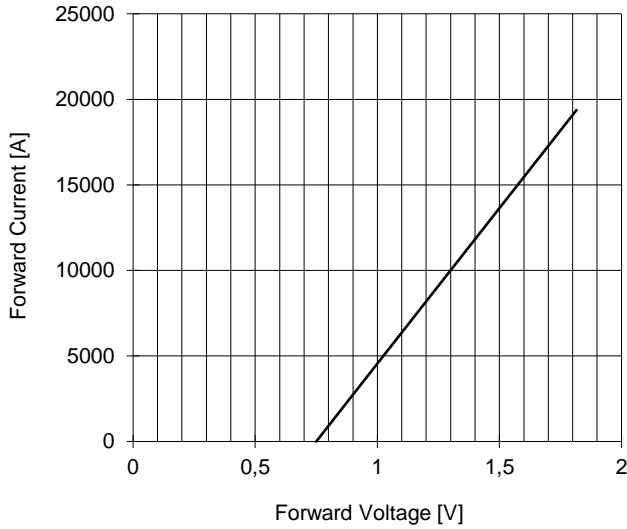

SURGE CHARACTERISTIC  
T<sub>j</sub> = 190 °C

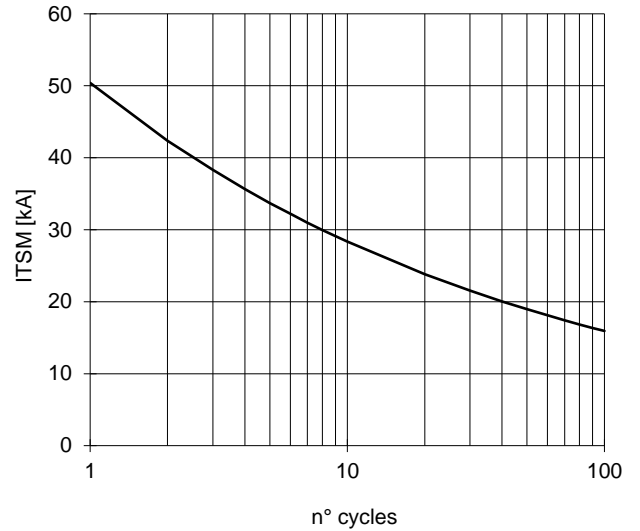

TRANSIENT THERMAL IMPEDANCE  
DOUBLE SIDE COOLED

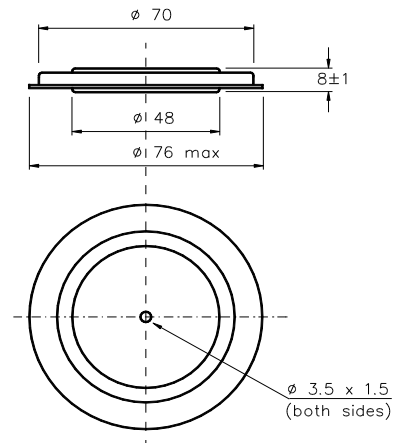
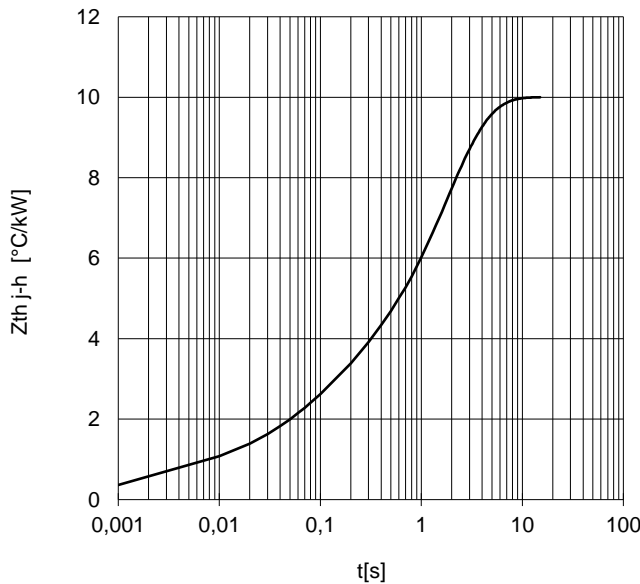

Dimensions  
in mm



Distributed by

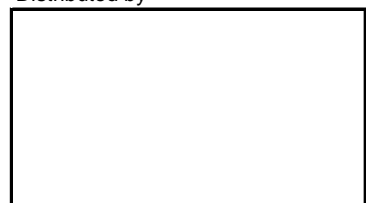

All the characteristics given in this data sheet are guaranteed only with uniform clamping force, cleaned and lubricated heatsink, surfaces with flatness < .03 mm and roughness < 2 μm.  
In the interest of product improvement POSEICO SpA reserves the right to change any data given in this data sheet at any time without previous notice.  
If not stated otherwise the maximum value of ratings (symbols over shaded background) and characteristics is reported.