

PHASE CONTROL MODULE

ATT250

Repetitive voltage up to

4000 V

Mean forward current

256 A

Surge current

6 kA

FINAL SPECIFICATION

Jan. 18 - Issue: 0

Symbol	Characteristic	Conditions	T _j [°C]	Value	Unit
BLOCKING					
V _{RRM}	Repetitive peak reverse/off-state voltage		125	4000	V
V _{RSM}	Non-repetitive peak reverse voltage		125	4100	V
I _{RRM/DRM}	Repetitive peak reverse/off-state current		125	75	mA
CONDUCTING					
I _{T(AV)}	Mean forward current	180° sin, 50 Hz, T _c =85°C, single side cooled		256	A
I _{T(AV)}	Mean forward current	180° sin, 50 Hz, T _c =55°C, single side cooled		377	A
I _{TSM}	Surge forward current	Sine wave, 10 ms	125	5,9	kA
I ² t	I ² t	without reverse voltage		174 x 10 ³	A ² s
V _T	On-state voltage	On-state current = 1600 A	25	3,50	V
V _{T(TO)}	Threshold voltage		125	1,35	V
r _T	On-state slope resistance		125	1,400	mohm
SWITCHING					
di/dt	Critical rate of rise of on-state current, min.	From 75% V _{DRM} up to 1050 A; gate 10V, 5Ω	125	200	A/μs
dv/dt	Critical rate of rise of off-state voltage, min.	Linear ramp up to 70% of V _{DRM}	125	500	V/μs
t _d	Gate controlled delay time, typical	V _D =100V; gate source 25V, 10Ω, tr=.5 μs	25	1,6	μs
t _q	Circuit commutated turn-off time, typical	dv/dt = 20 V/μs linear up to 75% V _{DRM}		320	μs
Q _{rr}	Reverse recovery charge	di/dt = -20 A/μs, I = 410 A	125		μC
I _{rr}	Peak reverse recovery current	V _R = 50 V			A
I _H	Holding current, typical	V _D =5V, gate open circuit	25	300	mA
I _L	Latching current, typical	V _D =5V, tp=30μs	25	700	mA
GATE					
V _{GT}	Gate trigger voltage	V _D =5V	25	3,50	V
I _{GT}	Gate trigger current	V _D =5V	25	200	mA
V _{GD}	Non-trigger gate voltage, min.	V _D =V _{DRM}	125	0,25	V
V _{FGM}	Peak gate voltage (forward)			30	V
I _{FGM}	Peak gate current			10	A
V _{RGM}	Peak gate voltage (reverse)			5	V
P _{GM}	Peak gate power dissipation	Pulse width 100 μs		150	W
P _G	Average gate power dissipation			2	W
MOUNTING					
R _{th(j-c)}	Thermal impedance, DC	Junction to case, per element		70,0	°C/kW
R _{th(c-h)}	Thermal impedance	Case to heatsink, per element		20,0	°C/kW
T _j	Operating junction temperature			-30 / 125	°C
V _{ins}	RMS insulation voltage	50 hz, circuit to base, all terminal shorted	25	4500	V
T	Mounting torque	Case to heatsink		4 to 6	Nm
T	Mounting torque	Busbars to terminal		12 to 18	Nm
	Mass			1500	g

ORDERING INFORMATION : ATT250 S 40

standard specification VRRM/100

FINAL SPECIFICATION Jan. 18 - Issue: 0

DISSIPATION CHARACTERISTICS

SQUARE WAVE

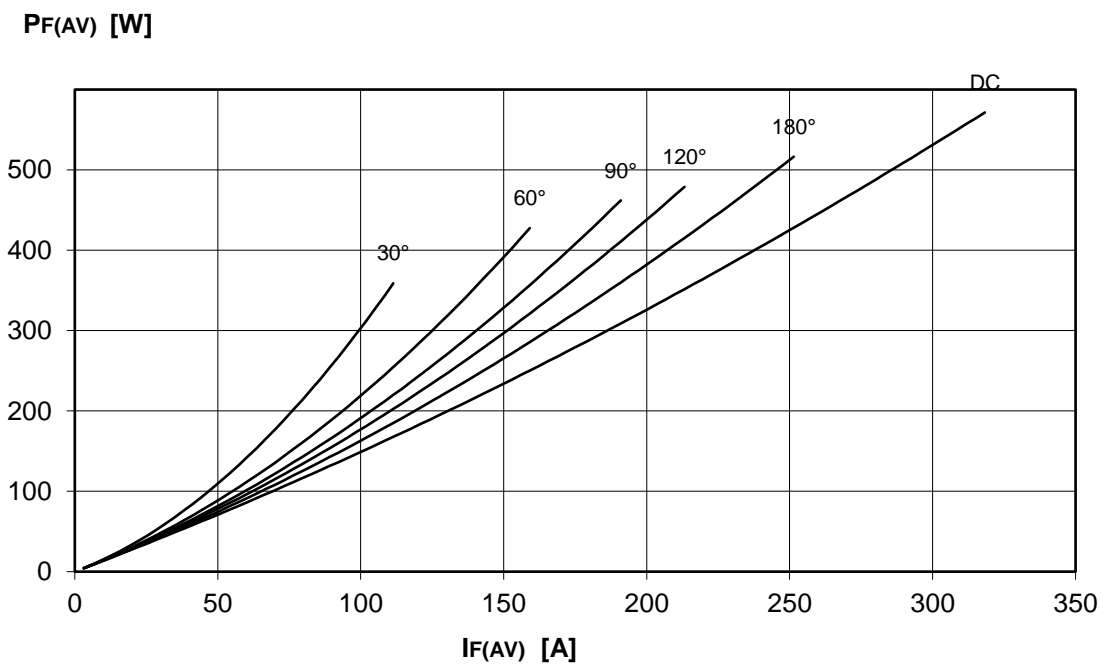
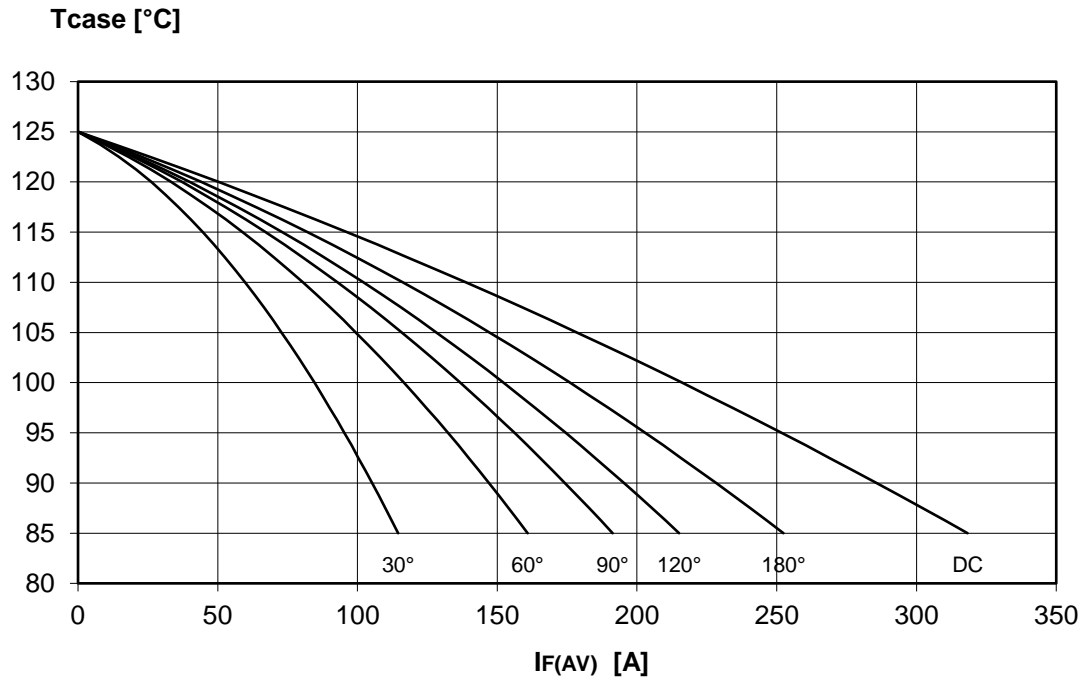

FINAL SPECIFICATION Jan. 18 - Issue: 0

DISSIPATION CHARACTERISTICS

SINE WAVE

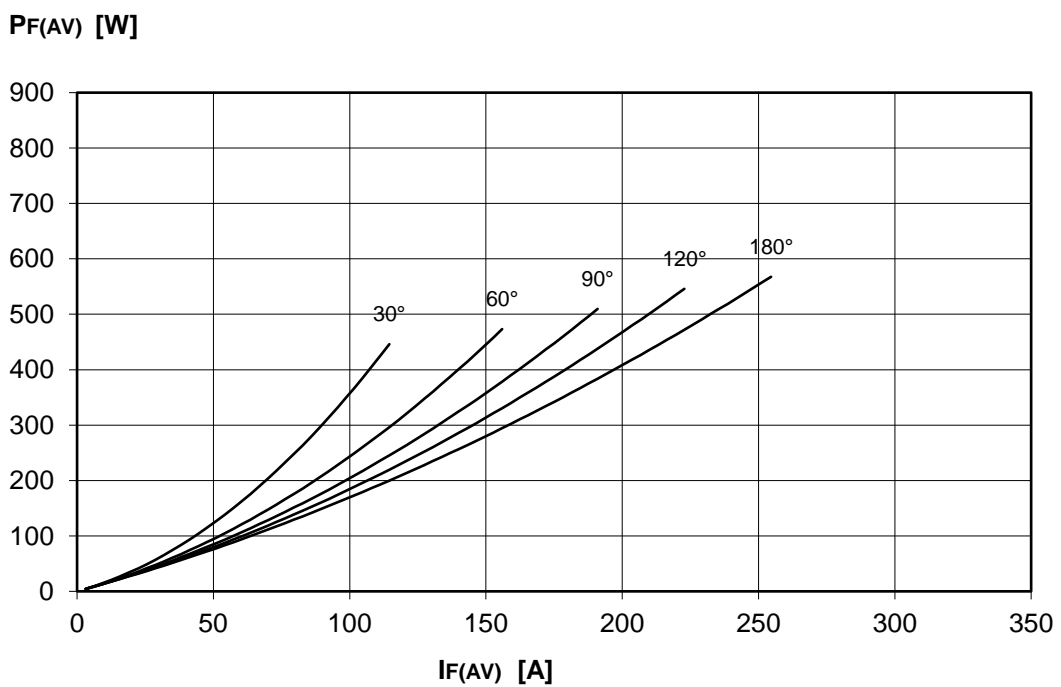
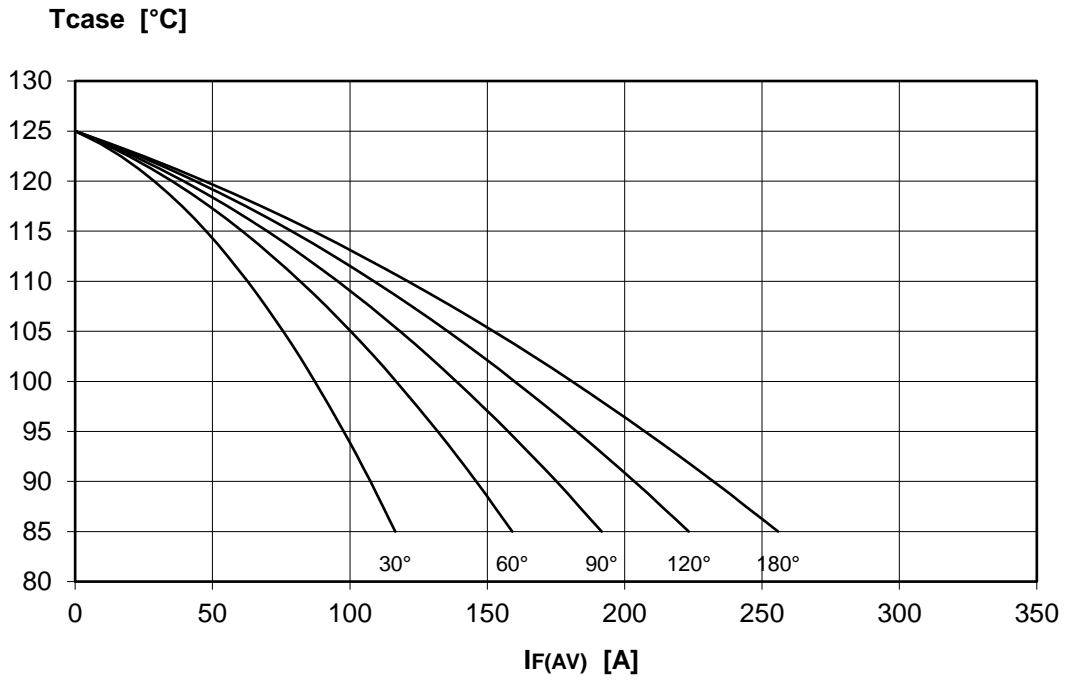

FINAL SPECIFICATION Jan. 18 - Issue: 0

ON-STATE CHARACTERISTIC
T_j = 125 °C

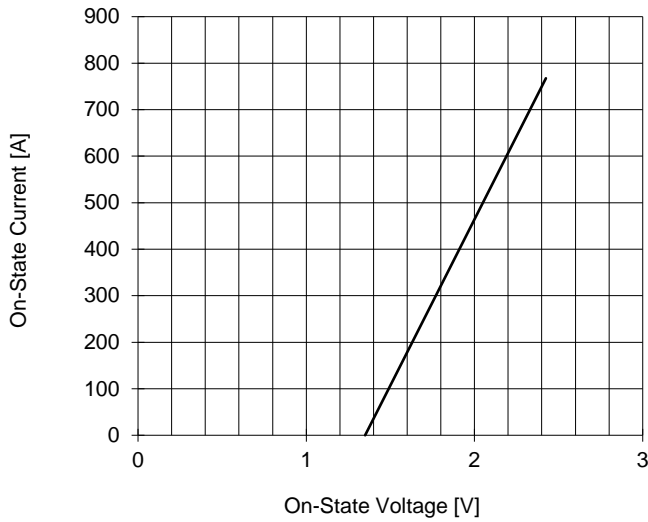

SURGE CHARACTERISTIC
T_j = 125 °C

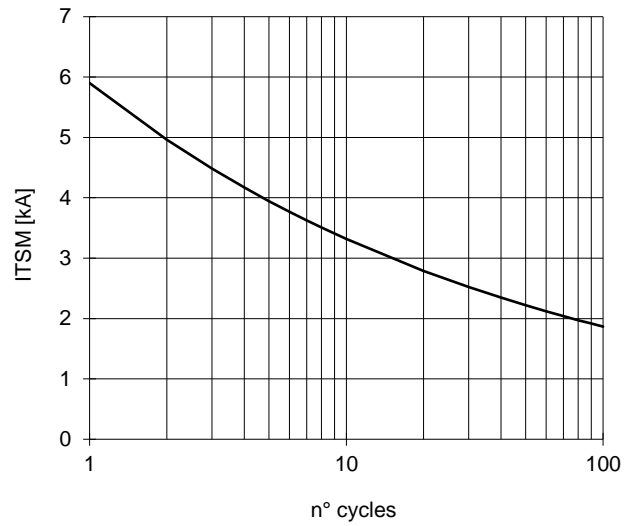

TRANSIENT THERMAL IMPEDANCE

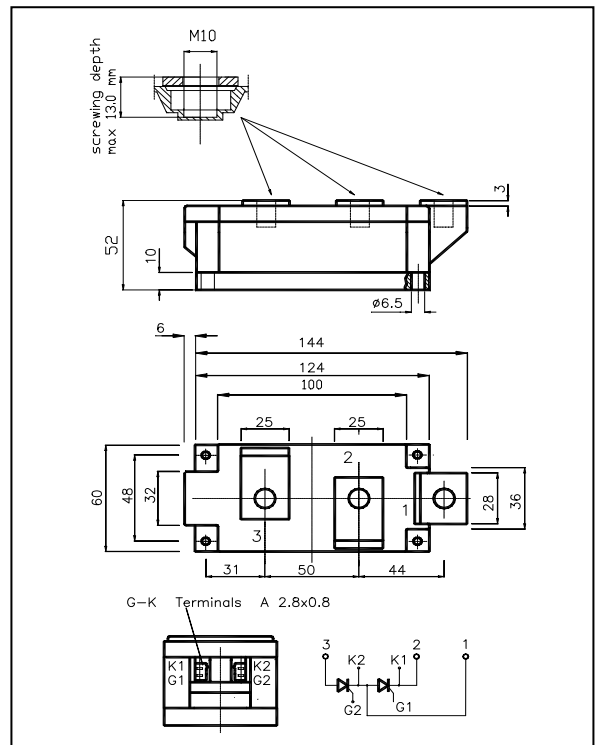
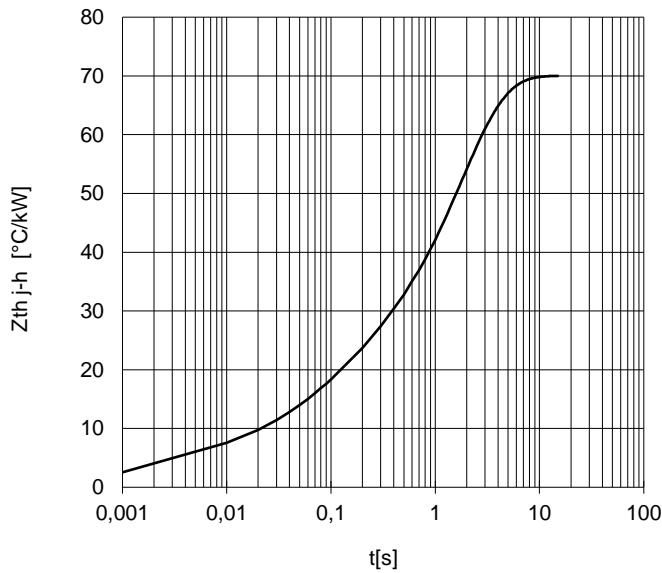

All the characteristics given in this data sheet are guaranteed only with uniform clamping force, cleaned and lubricated heatsink, surfaces with flatness < .03 mm and roughness < 2 μm. In the interest of product improvement POSEICO SpA reserves the right to change any data given in this data sheet at any time without previous notice. If not stated otherwise the maximum value of ratings (symbols over shaded background) and characteristics is reported.

Distributed by

